

# Day 1 吃吃喝喝

- menu
- meal
- dumpling
- spaghetti
- bake
- cookie
- toast
- bun
- hot dog
- soup
- hamburger
- cheese
- French fries
- drink
- coffee
- tea
- juice
- rice
- noodle
- egg
- crepe
- pudding
- doughnut
- chocolate
- candy
- ice
- ice cream
- popcorn
- cake
- pie
- pizza
- sandwich
- lettuce
- salt
- boil
- grape
- banana
- apple
- guava
- papaya
- watermelon
- pear
- orange
- fruit
- pumpkin
- vegetable

## menu

**fish** [fɪʃ]  
n. 鱼; 鱼类

**meat** [mit]  
n. (食用的) 肉

**steak** [stek]  
n. 牛排; 肉排; 鱼排

**ham** [hæm]  
n. 火腿

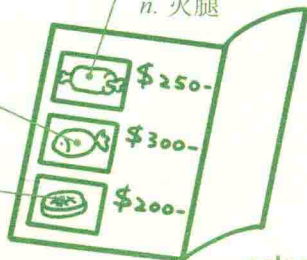

**menu** ['menju]  
n. 菜单

**main dish** [men dɪʃ]  
n. 主餐

**selection** [sə'leɪkʃən]  
n. 选择; 选拔

## meal

**steam** [stim]  
n. 蒸气

**carrot** ['kærət]  
n. 胡萝卜

**fork** [fɔrk]  
n. 叉子

**hot** [hət]  
adj. 热的

**cover** ['kʌvə]  
n. 盖子  
v. 遮盖; 覆盖

**bone** [bɒn]  
n. 骨头

**knife** [naɪf]  
n. 刀, 小刀; 餐刀

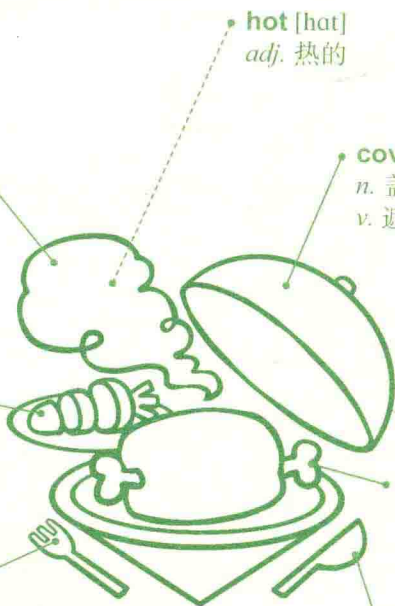

**meal** [mi:l]  
n. 膳食; 一餐

## dumpling

dumpling ['dʌmplɪŋ]

n. 饺子; 汤团

boiled dumpling

[bəʊld 'dʌmplɪŋ]

n. 水饺

\* fried dumpling

[fraɪd 'dʌmplɪŋ]

n. 煎饺

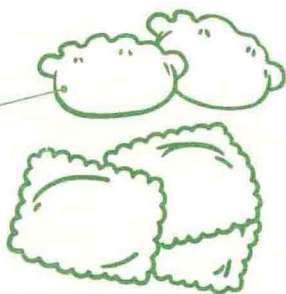

steamed [stɪmd]

adj. 蒸的

flour [flaʊr]

n. 面粉

boiled [bəʊld]

adj. 煮的

## spaghetti

spaghetti [spə'ɡetɪ]

n. 意大利面条

tomato sauce [tə'meto sɔ:s]

n. 番茄酱汁

\* 搭配薯条吃的番茄调味酱为

ketchup ['kætʃəp]

curl [kɜ:l]

v. 卷

stringy ['strɪŋj]

adj. 条状的

plate [plet]

n. 盘子; 盆; 碟

tomato [tə'meto]

n. 番茄

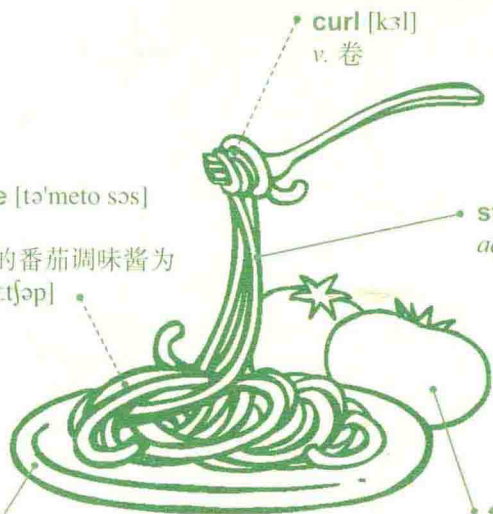

## bake

**bake** [bek]

*v.* 烘, 烤

*n.* 烘烤制成的食品

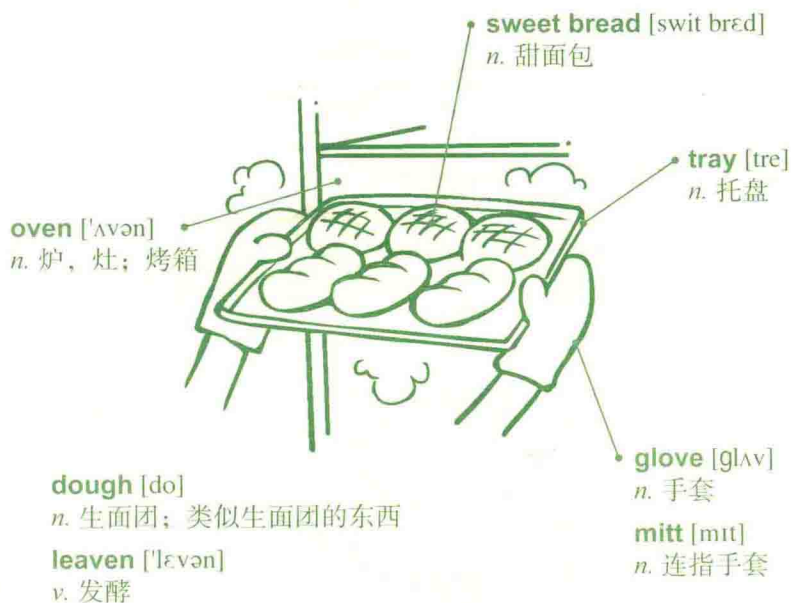

## cookie

**cookie** [ˈkuki]

*n.* 【美】甜饼干,  
(苏格兰)小面包

**assortment** [əˈsɔ:tmənt]  
*n.* 各式各样; 什锦

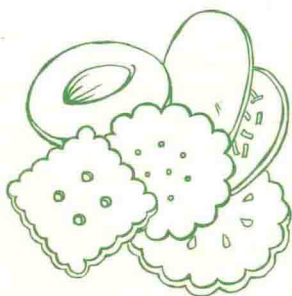

**crispy** [ˈkrɪspi]  
*adj.* 酥脆的

**baking** [ˈbeɪkɪŋ]  
*n.* 烘烤



## toast

**crust** [krʌst]  
n. 面包皮; 馅饼皮

**slice** [slɑ:s]  
n. 薄片, 片

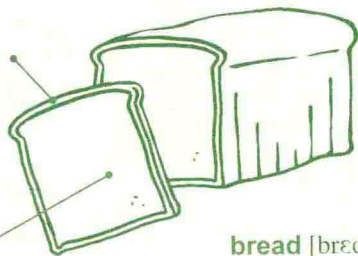

**toast** [tɔ:st]  
n. 吐司, 烤面包片

**loaf** [lɒf]  
n. (一条或一块) 面包

**bread** [brɛd]  
n. 面包

## bun

**raisin** ['reɪzn]  
n. 葡萄干

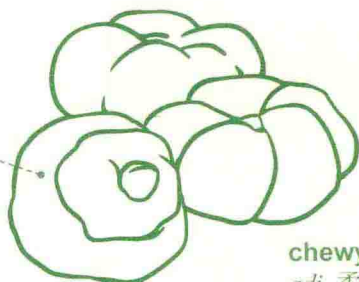

**bun** [bʌn]  
n. 小圆面包 (有时掺有葡萄干等); 小圆糕点

**soft** [sɒft]  
adj. 柔软的

**chewy** ['tʃu:ɪ]  
adj. 柔软而有黏性的

## hot dog

**ketchup** ['kɛtʃəp]  
n. 番茄调味酱 (= catchup)

**hot dog** [hɒt dɒg]  
n. 热狗

**mustard** ['mʌstəd]  
n. 黄芥末  
\* **wasabi** ['wæsæbi]  
n. 日式芥末

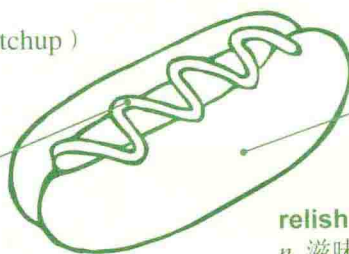

**bun** [bʌn]  
n. 面包

**relish** ['relɪʃ]  
n. 滋味, 风味

## soup

**soup** [sup]  
n. 汤

**liquid** ['lɪkwɪd]  
n. 液体

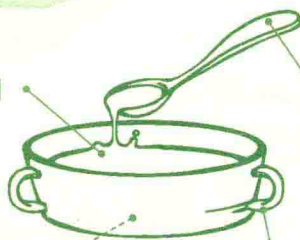

**spoon** [spun]  
n. 匙

\* **soup spoon** [sup spun]  
n. 汤勺; 汤匙

**container** [kən'teɪnə]  
n. 容器 (如箱、盒、罐等)

**handle** ['hændl]  
n. 柄, 把手; 柄状物

## hamburger

**hamburger** ['hæmbɜ:gə]  
n. 汉堡; 汉堡肉排

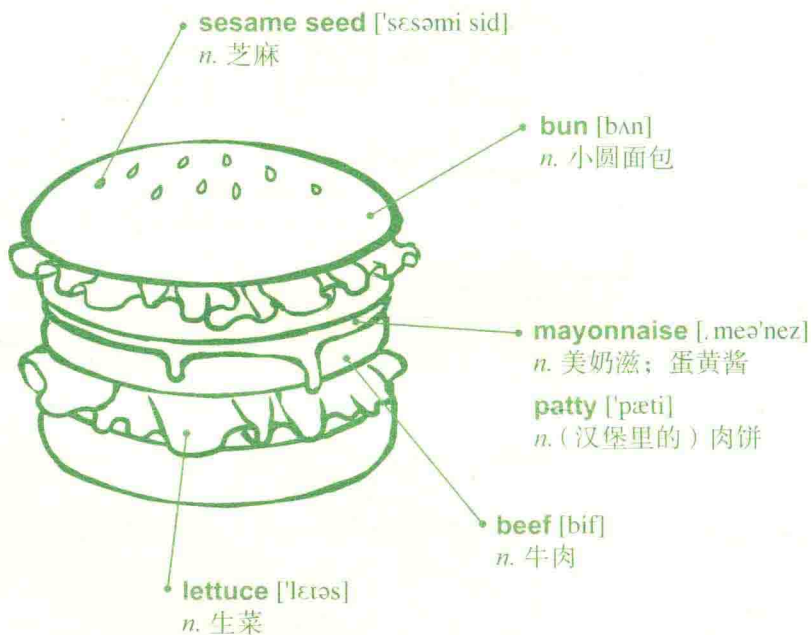

## cheese

**cheese** [tʃiːz]  
n. 芝士, 乳酪

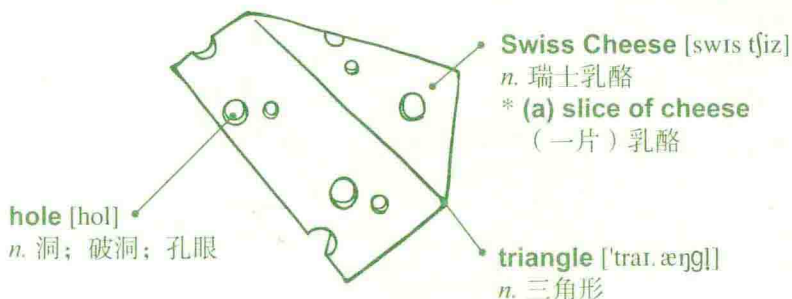

## French fries

**French fries** [fræntʃ 'fraɪz]  
n. 炸薯条

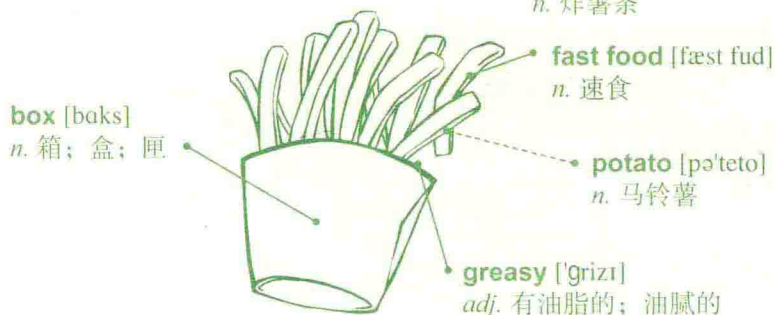

## drink

**drink** [drɪŋk]  
n. 饮料; 酒  
v. 饮, 喝

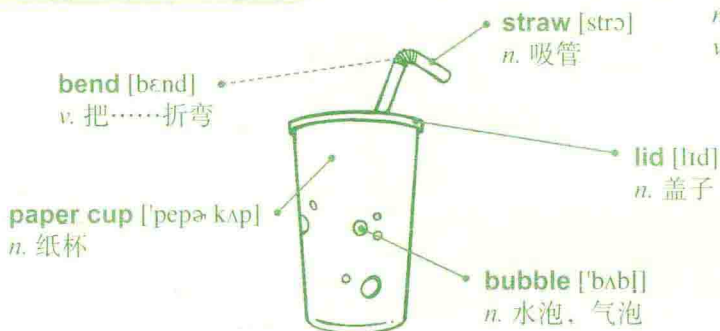

## coffee

**beverage** ['bevərɪdʒ]  
n. 饮料

**hot** [hɒt]  
adj. 热的

**coffee** ['kɒfi]  
n. 咖啡

**cup** [kʌp]  
n. 杯子

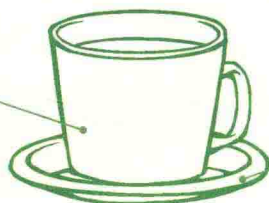

**liquid** ['lɪkwɪd]  
n. 液体

**saucer** ['sɔːsə]  
n. 茶托; 浅碟

## tea

**spout** [spaʊt]  
n. 壶嘴

**teapot** ['tiː.pət]  
n. 茶壶

**tea** [tiː]  
n. 茶; 茶叶

**pour** [pɔː]  
v. 倒, 灌, 注



**handle** ['hændl]  
n. 柄, 把手; 柄状物

**teacup** ['tiː.kʌp]  
n. 茶杯

## juice

**straw** [strɔː]  
n. 吸管

**juice** [dʒʊs]  
n. 果汁

**base** [beɪs]  
n. 杯座



**orange slice**  
['ɔːrɪndʒ sleɪs]  
n. 柑橘片

**stem** [stɛm]  
n. 杯脚; 茎

## rice

**rice** [raɪs]  
n. 稻, 谷; 米饭

**white** [hwaɪt]  
adj. 白色的

**delicious** [dɪ'liʃəs]  
adj. 美味的; 可口的

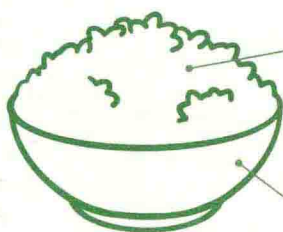

**cooked** [kʊkt]  
adj. 煮熟的

**bowl** [bɒl]  
n. 碗

## noodle

**noodle(s)** ['nu:dl]  
n. 面条

**soup** [sʊp]  
n. 汤

**chopstick(s)** ['tʃɒp.stɪk]  
n. 筷子



\* **beef noodles** [bif 'nu:dls]  
n. 牛肉面

**beef** [bif]  
n. 牛肉

## egg

**egg** [ɛɡ]  
n. 蛋; 鸡蛋

**shell** [ʃɛl]  
n. 蛋壳

**broken** ['brɒkən]  
adj. 破碎的

**fry** [fraɪ]  
v. 油煎

**egg white** [ɛɡ hwaɪt]  
n. 蛋白

**yolk** [jɒk]  
n. 蛋黄



## crepe

**delicious** [dɪ'lɪʃəs]  
*adj.* 美味的; 可口的

**hold** [hold]  
*v.* 握着; 抓住; 夹住



**crepe** [krep]  
*n.* 薄饼

**excited** [ɪk'saɪtɪd]  
*adj.* 兴奋的

## pudding

**spoon** [spun]  
*n.* 匙, 汤匙

**dessert** [dɪ'zɜ:t]  
*n.* 点心; 餐后甜点

**topping** ['tɒpɪŋ]  
*n.* (在上面的) 配料



**pudding** ['pu:dɪŋ]  
*n.* 布丁

**mouth** [mauθ]  
*n.* 嘴

**taste** [test]  
*v.* 尝起来

## doughnut

**icing** ['aɪsɪŋ]  
*n.* 糖霜; 糖衣

**yummy** ['jʌmɪ]  
*adj.* 【口】好吃的; 美味的

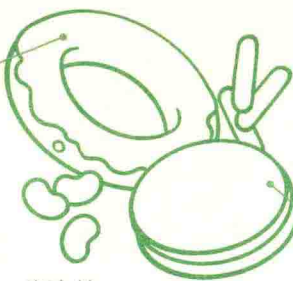

**doughnut** ['do:nʌt]  
*n.* 甜甜圈

**sweet** [swɪt]  
*adj.* 甜的

**pancake** ['pæn.kek]  
*n.* 松饼

## chocolate

**chocolate** ['tʃəkəlaɪt]  
n. 巧克力

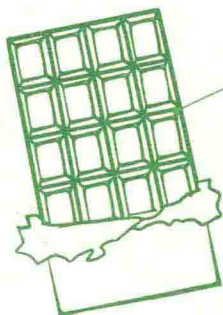

**creamy** ['kriːmi]  
adj. 含乳脂的

**square** [skwɛr]  
n. 正方形; 方块

**yummy** ['jʌmi]  
adj. 【口】好吃的; 美味的

**bitter** ['bɪtə]  
adj. 有苦味的, 苦的

## candy

**candy** ['kændi]  
n. 糖果

**lollipop** ['lɒlɪ.pɒp]  
n. 棒棒糖

**tasty** ['testi]  
adj. 【口】美味的

**candy wrapper**  
['kændi ræpə]  
n. 糖纸

**candy cane**  
['kændi ken]  
n. 拐杖糖



**stripe** [straɪp]  
n. 条纹, 线条

**mint** [mɪnt]  
n. 薄荷糖

## ice

**cold** [kɒld]  
*adj.* 冷的, 寒冷的

**dessert** [dɪ'zɜ:t]  
*n.* 餐后甜点

**character** ['kærɪktə]  
*n.* 字体; 汉字



**ice** [aɪs]  
*n.* 冰  
\* **shaved ice** [ʃeɪvd aɪs]  
*n.* 刨冰

**spoon** [spun]  
*n.* 匙, 汤匙

**bowl** [bɒl]  
*n.* 碗

## ice cream

**creamy** ['kri:mɪ]  
*adj.* 含乳脂的; 浓稠的

**flavor** ['flevə]  
*n.* 口味

**melt** [mɛlt]  
*v.* 融化; 熔化



**ice cream** [aɪs kri:m]  
*n.* 冰淇淋

**scoop** [skup]  
*v.* 用勺子挖  
*n.* 一勺; 勺子

**cone** [kon]  
*n.* 甜筒; 圆锥形

## popcorn

**salty** ['sɒltɪ]  
*adj.* 有盐分的; 咸味浓的

**bucket** ['bʌkɪt]  
*n.* 提桶

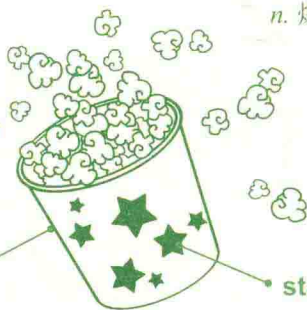

**popcorn** ['pɒp.kɔ:rn]  
*n.* 爆米花

**buttery** ['bʌtəri]  
*adj.* 奶油口味的

**star** [stɑ:]  
*n.* 星星形状



## cake

cake [keɪk]

n. 蛋糕, 糕饼

birthday ['bɜːθdeɪ]

n. 生日

flame [fleɪm]

n. 火焰; 火舌

candle ['kændl]

n. 蜡烛

icing ['aɪsɪŋ]

n. 糖霜; 糖衣

strawberry ['strɒberi]

n. 草莓



\* strawberry 的复数形为 strawberries

## pie

pie [paɪ]

n. 派 (附酥皮、有馅的饼); 馅饼

berry ['beri]

n. 浆果

crust [krʌst]

n. 馅饼皮

crumb [krʌm]

n. 碎屑

server ['sɜːvə]

n. 上菜用具

\* pie server [paɪ 'sɜːvə]

n. 派铲 (分切派用的小铲子)

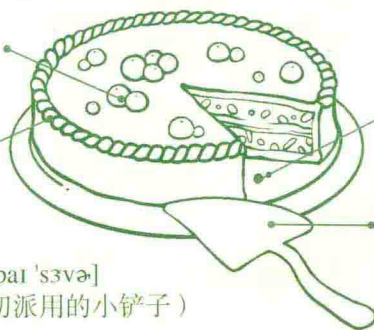

## pizza

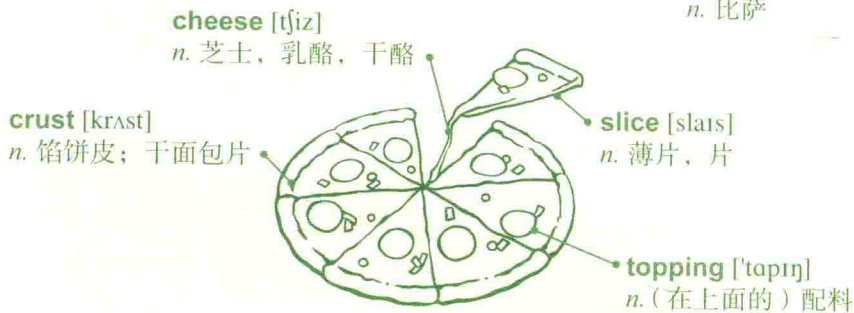

## sandwich

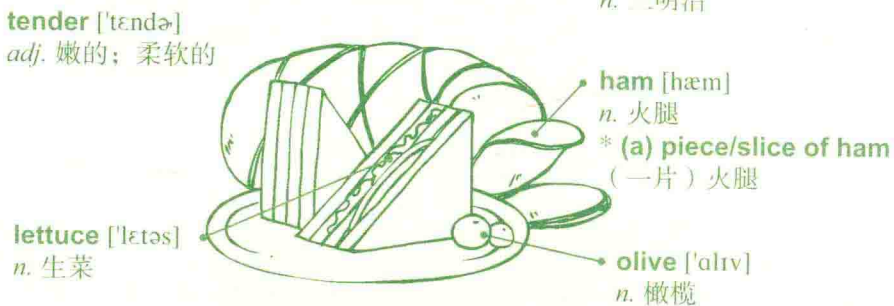

## lettuce

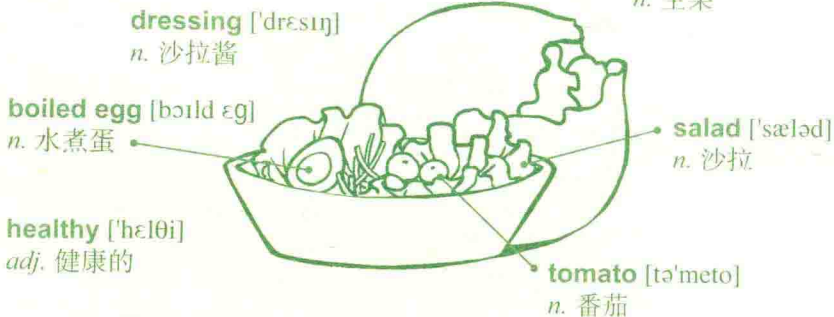

## salt

salt [sɔlt]

n. 盐

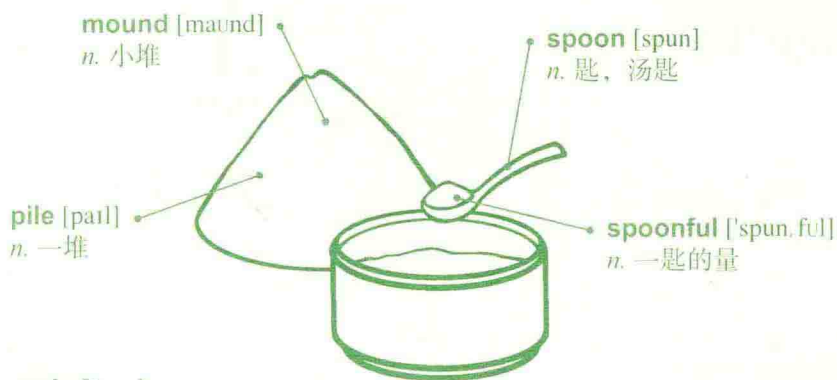

grain [graɪn]

n. (盐)粒; (谷)粒; 谷物

salty ['sɔltɪ]

adj. 有盐分的; 咸味浓的

## boil

boil [bɔɪl]

v. 沸腾, 烧开



cook [kuk]

v. 烹调, 煮

flame [fleɪm]

n. 火焰; 火舌

## grape

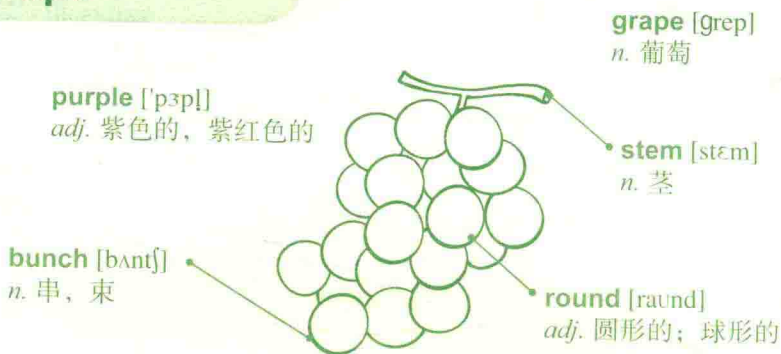

## banana



## apple

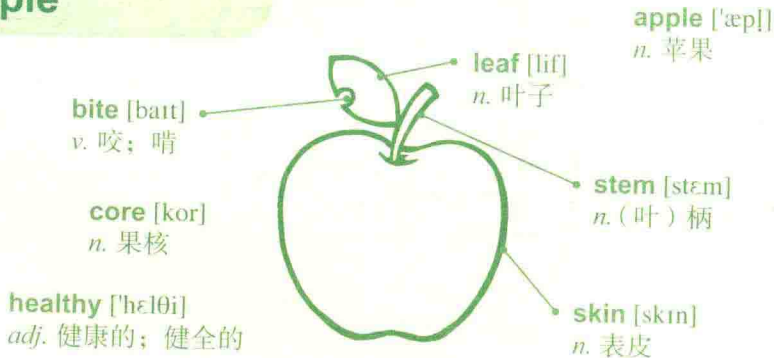

## guava

**oval** ['ovl]  
adj. 椭圆形的

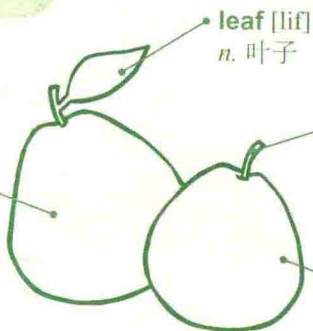

**leaf** [lif]  
n. 叶子

**stem** [stɛm]  
n. (叶) 柄

**green** [grɪn]  
adj. 绿色的

**guava** ['gwavə]  
n. 番石榴

## papaya

**papaya tree** [pə'pajə tri]  
n. 木瓜树

**trunk** [trʌŋk]  
n. 树干

**ripe** [raɪp]  
adj. 成熟的;  
适宜食用的, 醇美的

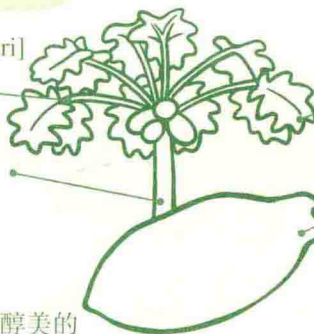

**leaf** [lif]  
n. 叶子

**orange** ['ɔrɪndʒ]  
adj. 橙色的

**tropical fruit** ['trɒpɪkəl fru:t]  
n. 热带水果

**papaya** [pə'pajə]  
n. 木瓜

## watermelon

**slice** [slɑ:s]  
n. 薄片, 片

**seed** [si:d]  
n. 籽

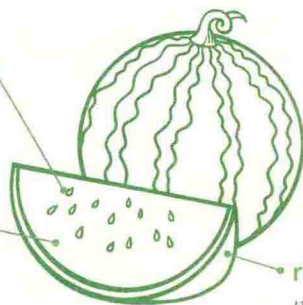

**rind** [raɪnd]  
n. 果皮

**juicy** ['dʒʊsi]  
adj. 多汁的

**watermelon**  
['wɔ:tə. mɛlɒn]  
n. 西瓜

## pear

**stem** [stɛm]

*n.* (叶)柄

**fork** [fɔ:k]

*n.* 叉子; 耙

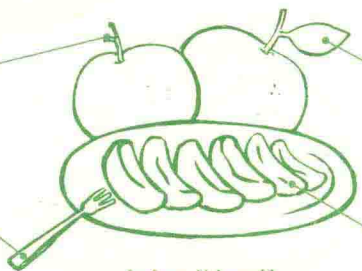

**pear** [pɛr]

*n.* 梨

**leaf** [li:f]

*n.* 叶子

**slice** [slɑ:s]

*n.* 薄片, 片

**juicy** ['dʒʊsi]

*adj.* 多汁的

## orange

**peel** [pi:l]

*n.* 果皮

*v.* 削去……的皮;  
剥去……的壳

**slice** [slɑ:s]

*n.* 薄片, 片

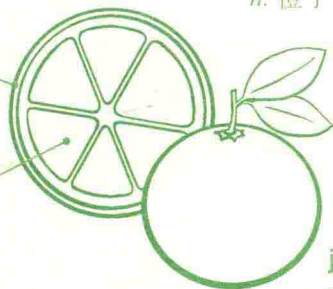

**orange** ['ɔ:ɪndʒ]

*n.* 橙子

**juicy** ['dʒʊsi]

*adj.* 多汁的

## fruit

**pear** [pɛr]

*n.* 梨

**tangerine** ['tændʒə.rɪn]

*n.* 橘子

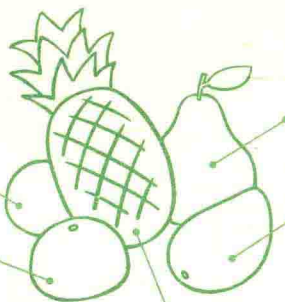

**fruit** [frut]

*n.* 水果

**avocado** [ævə'kʊdə]

*n.* 鳄梨

**mango** ['mæŋɡo]

*n.* 芒果

**pineapple** ['paɪn.æpl]

*n.* 菠萝

## pumpkin

crop [krɒp]

n. 作物, 庄稼

pumpkin ['pʌmpkɪn]

n. 南瓜

Halloween [ˌhæləʊ'ɪn]

n. 万圣节



orange ['ɒrɪndʒ]

adj. 橙色的

## vegetable

vegetable ['vedʒətəbəl]

n. 蔬菜

broccoli ['brækəli]

n. 西蓝花

green onion [grɪn 'ʌnjən]

n. 青葱

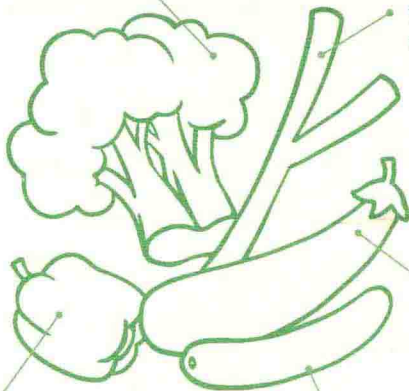

eggplant ['eg.plənt]

n. 茄子

green pepper [grɪn 'peɪpə]

n. 青椒

\* bell pepper [bɛl 'peɪpə]

n. 彩椒, 甜椒

( = sweet pepper [swit 'peɪpə] )

cucumber ['kju:kəmbə]

n. 黄瓜

# Day 2 休闲活动

- basketball
- baseball
- badminton
- tennis
- competition
- throw
- dodge ball
- soccer
- team
- jog
- run
- race
- roller-skate / skate
- sail
- row
- surf
- swim
- sandcastle
- river
- fishing
- camping
- campfire
- mountain
- compass
- map
- picnic
- hike
- balloon
- kite
- toy
- chess
- card
- drum
- guitar
- violin
- music
- sing
- flute
- piano
- opera
- concert



## basketball

**backboard** ['bæk, bɔ:d]  
n. 篮板

**game** [gem]  
n. 游戏; 运动

**dribble** ['drɪb]  
v. 运球

**net** [net]  
n. 篮网



**basketball** ['bæskɪt, bɔ:l]  
n. 篮球运动; 篮球

**shoot** [ʃu:t]  
v. 投篮

**hoop** [hup]  
n. 篮框

**score** [skɔ:r]  
n. (比赛中的) 得分, 比分

## baseball

**play** [pleɪ]  
v. 打球

**bat** [bæt]  
n. (棒球, 板球的)  
球棒; (桌球等的) 球拍

**glove** [glɒv]  
n. 手套

**catch** [kætʃ]  
v. 接(住)

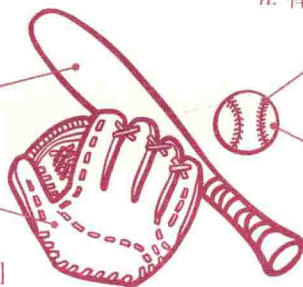

**baseball** ['bes, bɔ:l]  
n. 棒球运动; 棒球

**stitch** [stɪtʃ]  
n. 缝线; 针脚

**ball** [bɔ:l]  
n. 球

**hit** [hɪt]  
v. 打击

## badminton

**string** [strɪŋ]  
n. 线; 细绳; 带子

**racket** ['rækɪt]  
n. 羽毛球拍; 网球拍

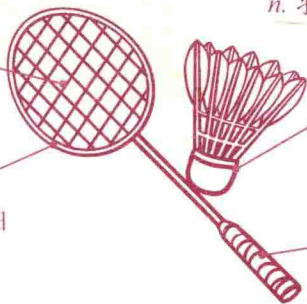

**badminton** ['bædmɪntən]  
n. 羽毛球

**birdie** ['bɜ:di]  
n. 羽毛球

**handle** ['hændl]  
n. 柄; 握把

## tennis

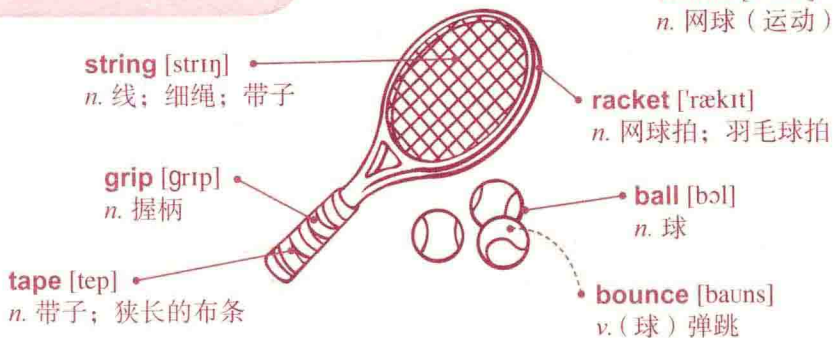

## competition

**competition** [ˌkæmpə'tɪʃən]  
n. 竞争; 比赛

**celebrate** [ˈseləbreɪt]  
v. 庆祝

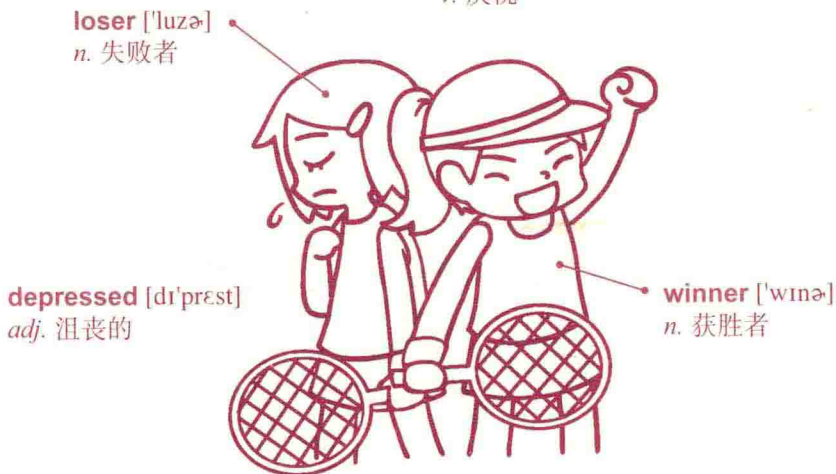

**game** [ɡeɪm]  
n. 游戏; 运动

## throw

**sneaker(s)** ['sni:kə]

*n.* [口] 球鞋

\* throw 的三种时态为  
throw/throw/throw



**throw** [θro]

*v.* 投, 扔



**ball** [bɔl]

*n.* 球; 球状体

## dodge ball

**dodge ball** ['dɒdʒ ,bɔl]

*n.* 躲避球

**afraid** [ə'freɪd]

*adj.* 害怕的

**dodge** [dɒdʒ]

*v.* 闪开, 躲开

**player** ['pleɪ]

*n.* 选手; 玩游戏的人

**running shoe(s)**

['rʌnɪŋʃu]

*n.* 运动鞋



**throw** [θro]

*v.* 掷, 扔

# soccer

**soccer** ['səkə]

*n.* 足球; 足球比赛



# team

**team** [ti:m]

*n.* 队, 团队

**teammate** ['ti:m. met]

*n.* 队友

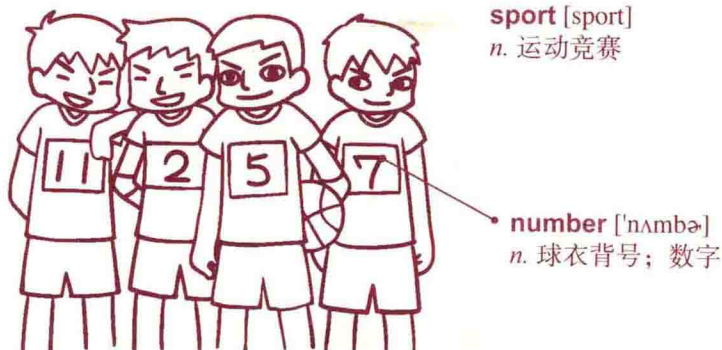

## jog

**headband** ['hɛd.bænd]

*n.* 头带; 发带

**runner** ['rʌnə]

*n.* 跑步者; 赛跑者



**jog** [dʒɔg]

*v.* 慢跑

**exercise** ['ɛksə.sɪz]

*n.* 运动

**running shoe(s)**

['rʌnɪŋʃu]

*n.* 运动鞋; 慢跑鞋

## run

**runner** ['rʌnə]

*n.* 赛跑者

**race** [res]

*n.* 赛跑

**pompon** ['pʌmpən]

*n.* 彩球



**run** [rʌn]

*v.* 跑

**cheer** [tʃɪr]

*n.* 欢呼

**cheerleader** ['tʃɪr.li:də]

*n.* 啦啦队长

**root for** [rut fɔ]

*ph.* 【口】为……欢呼加油

## race

**ecstatic** [ɛk'stætɪk]

*adj.* 很高兴的

**champion** ['tʃæmpɪən]

*n.* 优胜者



**race** [res]

*n.* 赛跑

**win** [wɪn]

*v.* 获胜

**finish** ['fɪnɪʃ]

*v.* 结束; 完成

**ribbon** ['rɪbən]

*n.* 缎带; 彩带

\* win 的三种时态为 win/won/won

## roller-skate / skate

roller-skate ['rɒlə,sket]

v. 溜旱冰; 溜直排轮



skate [sket]

v. 溜冰; 滑冰

ice-skating

['aɪs,sketɪŋ]

n. 滑冰





## sail

**windy** ['wɪndi]  
adj. 刮风的; 风大的

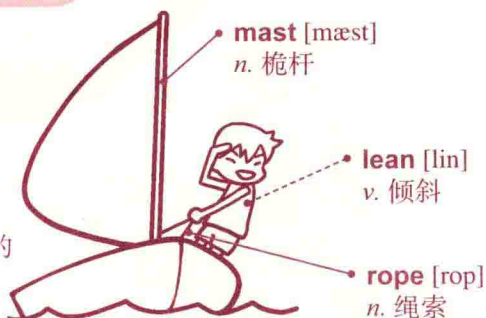

**sail** [seɪ]  
n. 帆, 船帆  
v. 航行; 驾船

## row

**stroke** [stroʊk]  
n. 划

**boat** [boʊt]  
n. 小船

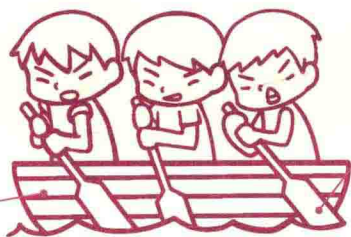

**row** [roʊ]  
v. 划(船)

## surf

**web page** [wɛb peɪdʒ]  
n. 网页

**Internet** ['ɪntə.net]  
n. 互联网

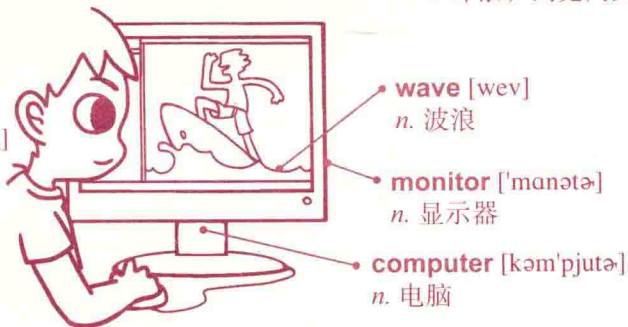

**surf** [sɜːf]  
v. 冲浪; 浏览网页

## swim

swim [swɪm]

v. 游泳

\* backstroke ['bæk, strok]

n. 仰泳

\* breaststroke ['brɛst, strok]

n. 蛙泳

front crawl [frʌnt kɹɔ:l]

n. 自由泳

swimming cap ['swɪmɪŋ kæp]

n. 泳帽

goggles ['gɒgls]

n. 泳镜



## sandcastle

sandcastle ['sænd.kæsl]

n. 沙堡

make [meɪk]

v. 做; 建造

fort [fɔ:t]

n. 堡垒

mound [maʊnd]

n. 土石堆; 土堤





## river

river ['rɪvə]

n. 河流

flow [flo]

v. (河水) 流动

riverbank ['rɪvə, bæŋk]

n. 河堤

grass [græs]

n. 青草

current ['kʌrənt]

n. 水流

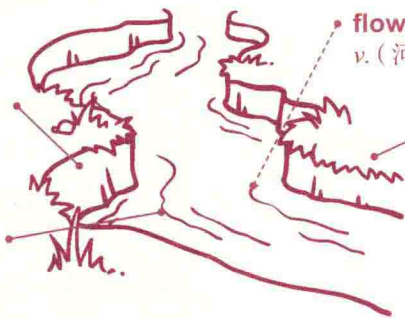

## fishing

fishing ['fɪʃɪŋ]

n. 钓鱼

fishing rod ['fɪʃɪŋ rɒd]

n. 钓竿

pull [pul]

v. 拉

catch [kætʃ]

v. 抓住

gill [gɪl]

n. 鱼鳃

fin [fɪn]

n. 鱼鳍

pond [pɒnd]

n. 池塘

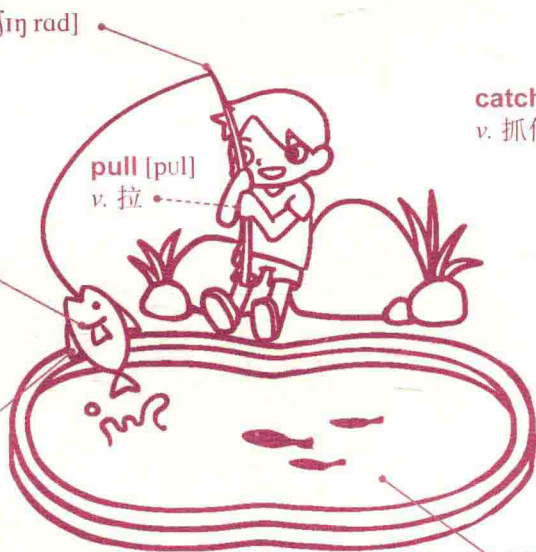

## camping

**camping** [kæmpɪŋ]

*n.* 露营

**campsite** ['kæmp, saɪt]

*n.* 露营地

**tent** [tɛnt]

*n.* 帐篷

**campfire** ['kæmp, faɪr]

*n.* 篝火

**peg** [pɛɡ]

*n.* 营钉; 营桩



## campfire

**campfire** ['kæmp, faɪr]

*n.* 篝火

**hot chocolate** [hət 'tʃɒkəlɪt]

*n.* 热巧克力 (饮料)

**warm** [wɔ:m]

*adj.* 温暖的, 暖和的



**coat** [kəʊt]

*n.* 外套

**wood** [wud]

*n.* 木头

\* **build a campfire**

生篝火

## mountain

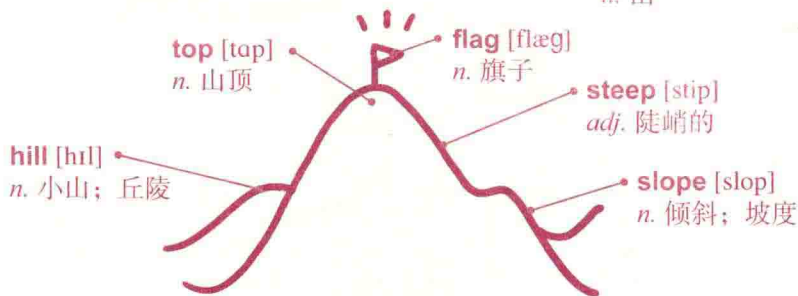

**mountain** ['maʊntən]  
n. 山

## compass

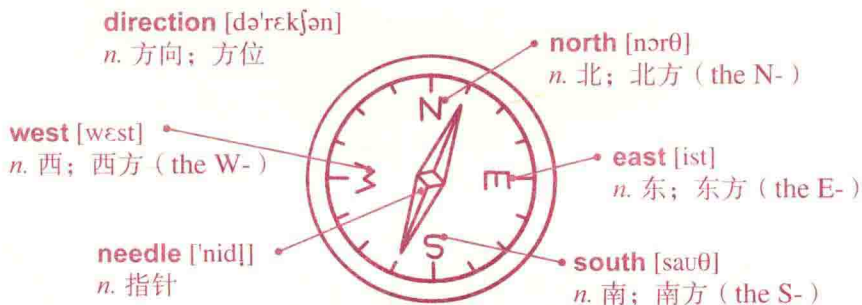

**compass** ['kʌmpəs]  
n. 指南针

## map

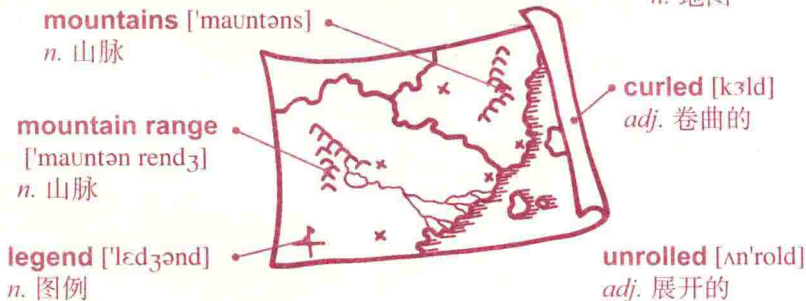

**map** [mæp]  
n. 地图

## picnic

chat [tʃæt]

v. 闲聊

picnic ['pɪknɪk]

n. 野餐



enjoy [ɪn'dʒɔɪ]

v. 享受

picnic basket ['pɪknɪk 'bæskɪt]

n. 野餐提篮

blanket ['blæŋkɪt]

n. 野餐布; 毯子

## hike

hike [haɪk]

v. 健行, 远足

mountain ['maʊntən]

n. 山

cap [kæp]

n. 帽子

backpack ['bæk.pæk]

n. 背包

path [pæθ]

n. 小径, 步道

trail [treɪl]

n. 步道

walking stick ['wɒkɪŋ stɪk]

n. 登山杖



## balloon

**balloon** [bə'lun]  
*n.* 气球

**hot air balloon** [hət ɛr bə'lun]  
*n.* 热气球

**float** [flot]  
*v.* 飘浮; 漂浮

**basket** ['bæskɪt]  
*n.* 篮子

**sandbag** ['sænd.bæg]  
*n.* 沙袋

**passenger** ['pæsəndʒə]  
*n.* 乘客

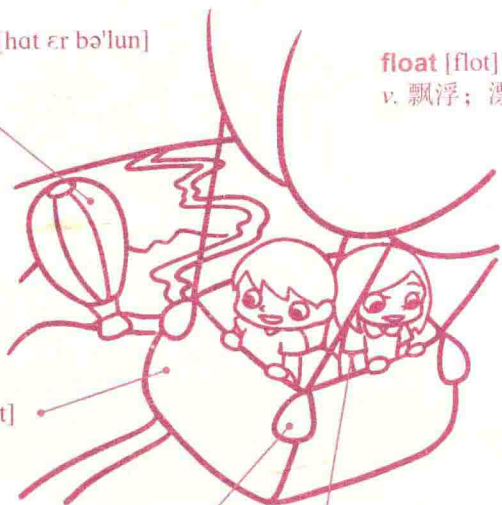

## kite

**kite** [kaɪt]  
*n.* 风筝

**string** [strɪŋ]  
*n.* 线; 绳

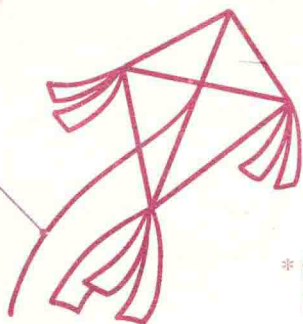

\* **fly a kite**  
放风筝

## toy

toy [tɔɪ]

n. 玩具

rectangle [rɛk'tæŋɡl]

n. 长方形; 矩形

triangle ['traɪ.æŋɡl]

n. 三角形

block [blak]

n. 积木

car [kɑː]

n. 汽车

doll [dɒl]

n. 玩偶

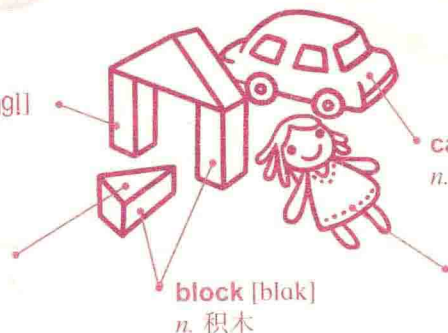

## chess

chess [tʃɛs]

n. 国际象棋

rook [ruːk]

n. (国际象棋里的) 车, 城堡

chessboard ['tʃɛs.bɔːd]

n. 棋盘

pawn [paʊn]

n. 兵; 卒

square [skwɛr]

n. 正方形

knight [naɪt]

n. 骑士

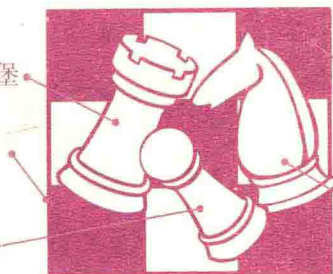

## card

card [kɑːd]

n. 纸牌

club [klʌb]

n. 梅花; 社团

diamond ['daɪəmənd]

n. 方块; 钻石

heart [hɑːt]

n. 红心; 心脏

spade [speɪd]

n. 黑桃; 铲

gamble ['ɡæmbəl]

v. 赌博

hand [hænd]

n. 手牌



## drum

**rhythm** ['rɪðəm]

*n.* 节奏

**bang** [bæŋ]

*v.* 砰砰作响

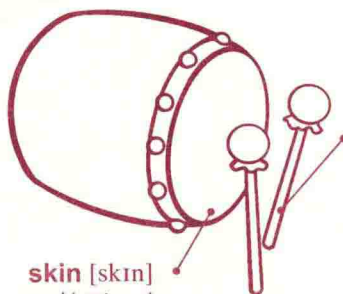

**skin** [skɪn]

*n.* 鼓面; 皮

**drumstick** ['drʌm.stɪk]

*n.* 鼓棒, 鼓槌

**beat** [bit]

*v.* 击打

**drum** [drʌm]

*n.* 鼓

## guitar

**body** ['bɒdɪ]

*n.* 琴身; 身体

**strum** [strʌm]

*v.* (随意地) 弹拨

**peg** [pɛɡ]

*n.* 琴栓; 弦轴; 钉



**string** [strɪŋ]

*n.* 琴弦; 线

**pluck** [plʌk]

*v.* 拨奏

**guitar** [grɪ'tɑː]

*n.* 吉他

## violin

**peg** [pɛɡ]

*n.* 琴栓; 弦轴; 钉

**string** [strɪŋ]

*n.* 琴弦; 线

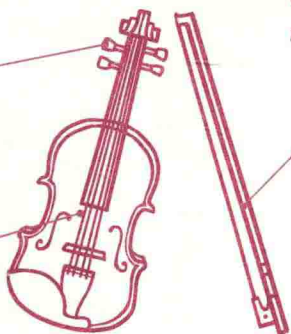

**violin** [,vaɪə'lɪn]

*n.* 小提琴

**bow** [bo]

*n.* 琴弓



## music

**note** [nɒt]  
n. 音符

**melody** ['melədi]  
n. 曲调; 好听的声音



**music** ['mju:zɪk]  
n. 音乐

**listen** ['lɪsən]  
v. 聆听

**headphones** ['hɛd.fɒnz]  
n. 头戴式耳机

## sing

**karaoke** [.kəri'ɒki]  
n. 卡拉OK



**microphone** ['maɪkrə.fən]  
n. 麦克风

**voice** [vɔɪs]  
n. 声音; 嗓子

**cord** [kɔ:d]  
n. 粗线

**singer** ['sɪŋə]  
n. 歌手

## flute

**flute** [flut]

*n.* 长笛

**sound** [saund]

*n.* 声音



**blow** [blo]

*v.* 吹(奏); 刮(风)

**perform** [pə'fɔ:m]

*v.* 表演

**press** [prɛs]

*v.* 按压

**practice** ['præktɪs]

*v.* 练习

## piano

**piano** [pi'æno]

*n.* 钢琴

**play** [ple]

*v.* 弹奏

**piano key** [pi'æno ki]

*n.* 琴键



**music sheet**

['mjuzɪk ʃi:t]

*n.* 琴谱

**bench** [bɛntʃ]

*n.* 长凳

**tune** [tjun]

*n.* 歌曲; 旋律

## opera

**sing** [sɪŋ]  
v. 唱, 唱歌

**concentrate** ['kɒnsəntreɪt]  
v. 专注



**opera** ['ɒpərə]  
n. 歌剧

**singer** ['sɪŋə]  
n. 歌唱家

## concert

**performer** [pə'fɔ:mə]  
n. 演奏者; 表演者

**concert** ['kɒnsət]  
n. 音乐会, 演奏会

**musician** [mju:'zɪʃən]  
n. 音乐家



**rock music** [rɒk 'mju:zɪk]  
n. 摇滚乐

**electric guitar** [ɪ'lektrɪk ɡɪ'tɑː]  
n. 电吉他

# Day 3 动植物

- lion
- tiger
- bear
- zebra
- horse
- fox
- cat
- dog
- cow
- ox
- sheep
- goat
- turkey
- snake
- dragon
- monkey
- koala
- kangaroo
- hippo
- zoo
- turtle
- whale
- shark
- elephant
- rabbit
- mouse
- pig
- goose
- duck
- chicken
- bird
- butterfly
- grasshopper
- toad
- bat
- bee
- spider
- ant
- cicada
- seed
- turnip
- plant
- tree
- bush
- bean
- rose
- flower

## lion

**ferocious** [fə'roʃəs]  
*adj.* 凶猛的

**lion** ['laɪən]  
*n.* 狮子



## tiger

**feline** ['fɪlɪn]  
*n.* 猫科动物

**tiger** ['taɪgə]  
*n.* 老虎

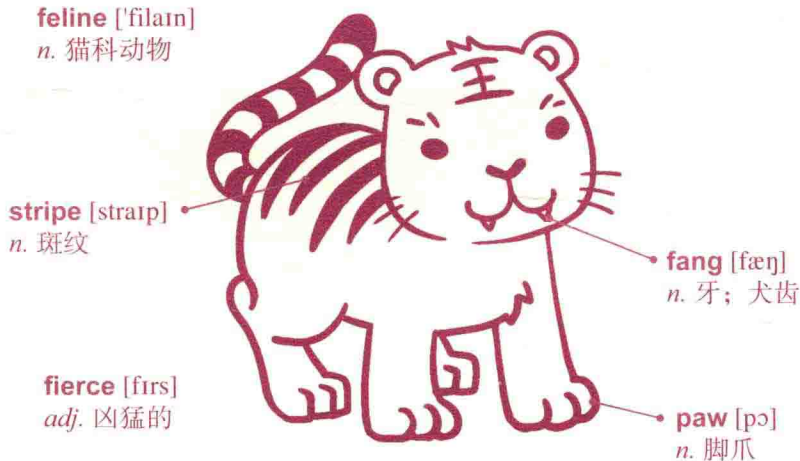

## bear

**sore** [sor]  
adj. 疼痛的

**pain** [pen]  
n. 痛苦



**Band-Aid** ['bænd.ed]  
n. 创可贴

**tear** [tɪr]  
n. 泪珠

**cry** [kraɪ]  
v. 哭

**bear** [bɛr]  
n. 熊

## zebra

**nostril** ['nɑstrɪl]  
n. 鼻孔

**hoof** [huf]  
n. 蹄

**mane** [men]  
n. 鬃毛

**stripe** [straɪp]  
n. 条纹

**tail** [teɪ]  
n. 尾巴



**zebra** ['zɪbrə]  
n. 斑马

## horse

**chew** [tʃu]  
v. 咀嚼

**carrot** ['kærət]  
n. 胡萝卜

**top** [tɒp]  
n. 顶部

**mane** [men]  
n. 鬃毛

**stand** [stænd]  
v. 站立



**horse** [hɔrs]  
n. 马

## fox

**whisker** ['hwɪskə]  
n. 动物的须

**breast** [brɛst]  
n. 胸部

**bushy** ['buʃɪ]  
adj. 毛茸茸的

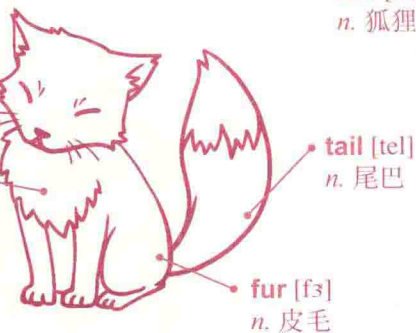

**fox** [fɒks]  
n. 狐狸

**tail** [teɪl]  
n. 尾巴

**fur** [fɜː]  
n. 皮毛

## cat

**whisker** ['hwɪskə]  
n. 动物的须

**bell** [bɛl]  
n. 铃铛

**ball** [bɔːl]  
n. 球

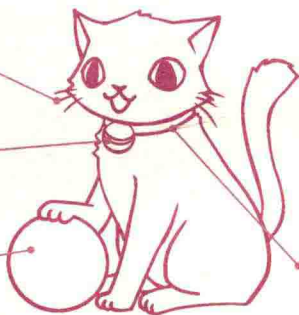

**cat** [kæt]  
n. 猫

**collar** ['kɒlə]  
n. 项圈

## dog

**puppy** ['pʌpi]  
n. 小狗, 幼犬

**Frisbee** ['frɪzbi]  
n. 飞盘

**catch** [kætʃ]  
v. 接住

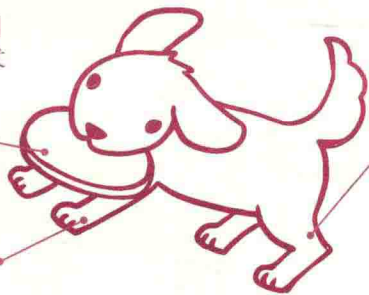

**dog** [dɒg]  
n. 狗

**hind leg** [haɪnd leɪg]  
n. 后腿

**play** [pleɪ]  
v. 玩耍

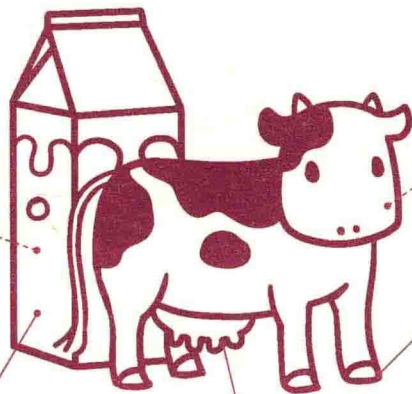

## COW

**dairy** ['deəri]*n.* 乳酪场; 牛奶场**milk** [mɪlk]*n.* 乳; 牛奶**carton** ['kɑ:tən]*n.* 新鲜屋 (可装液体的纸盒); 纸盒**cow** [kau]*n.* 母牛; 乳牛**moo** [mu]*v.* 哞哞叫**hoof** [huf]*n.* 蹄**udder** ['ʌdə]*n.* (母牛或母羊的) 乳房

## OX

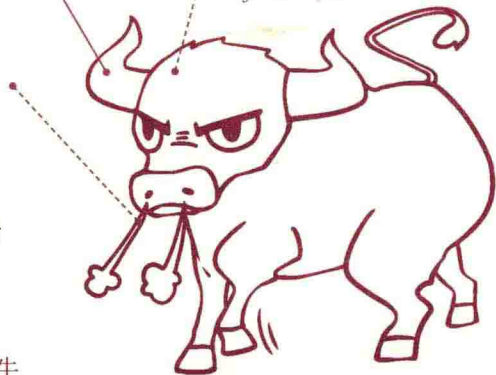
**ox** [aks]*n.* 公牛**horn** [hɔ:n]*n.* 角**angry** ['æŋgri]*adj.* 生气的**puff** [pʌf]*v.* (从鼻子) 喷气**charge** [tʃɑ:dʒ]*v.* 向……冲去; 攻击**bull** [bul]*n.* (未阉割过的) 公牛

## sheep

**baa** [ba]  
v. 咩咩叫

**fluffy** ['flʌfɪ]  
adj. 毛茸茸的; 蓬松的

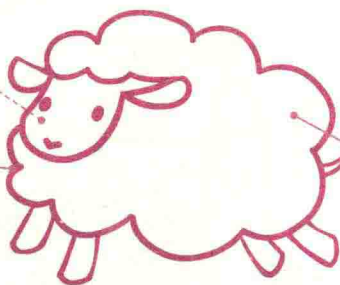

**sheep** [ʃip]  
n. 绵羊

**wool** [wʊl]  
n. 羊毛

**fleece** [fli:s]  
n. 羊毛

\* sheep 的复数形仍为 sheep

## goat

**horn** [hɔ:n]  
n. 角

**underbelly** ['ʌndə, bɛli]  
n. 下腹部

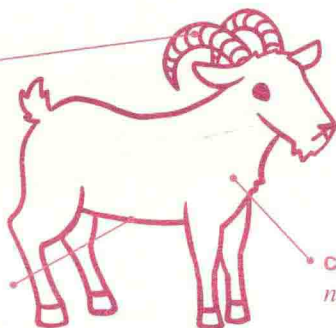

**goat** [gɔ:t]  
n. 山羊

**ram** [ræm]  
n. 公羊

**chest** [tʃɛst]  
n. 胸

## turkey

**beak** [bik]  
n. 鸟嘴; 喙状嘴

**gobble** ['gɒbl]  
v. (火鸡) 咕噜噜叫

**claw** [klɔ:  
n. 鸟爪

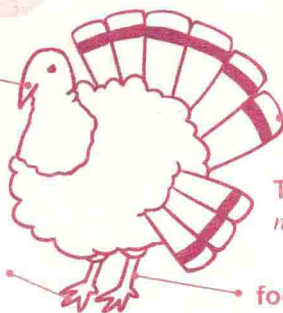

**turkey** ['tɜ:ki]  
n. 火鸡

**feather** ['feðə]  
n. 羽毛

**Thanksgiving** ['θæks, grɪvɪŋ]  
n. 感恩节

**foot** [fʊt]  
n. 脚

## snake

snake [sneɪk]

n. 蛇

tail [teɪl]

n. 尾巴

hiss [hɪs]

v. 发出嘶嘶声

forked tongue [fɔːkt tʌŋ]

n. 蛇信

coil [kɔɪl]

v. 卷, 盘绕

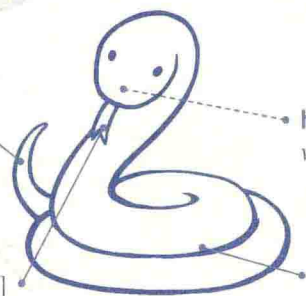

## dragon

dragon ['dræɡən]

n. 喷火龙

legendary [ˈledʒəndəri]

adj. 传说的

mythology [mɪˈθɒlədʒi]

n. 神话

Chinese dragon [ˈtʃaɪnɪz 'dræɡən]

n. 龙



## monkey

monkey ['mʌŋki]

n. 猴子

swing [swɪŋ]

v. 摆动

grab [græb]

v. 抓握

agile [ˈædʒaɪl]

adj. 敏捷轻快的

hang [hæŋ]

v. 吊挂



## koala

**snout** [snaʊt]  
*n.* 动物的口鼻

**hug** [hʌg]  
*v.* 紧抱

**cling** [klɪŋ]  
*v.* 紧握不放



**koala** [koʻɑlə]  
*n.* 考拉

**furry** [ˈfɜːi]  
*adj.* 有毛皮的

**adorable** [əˈdɔrəbəl]  
*adj.* 可爱的

## kangaroo

**hop** [hɒp]  
*v.* 蹦跳

**jump** [dʒʌmp]  
*v.* 跳

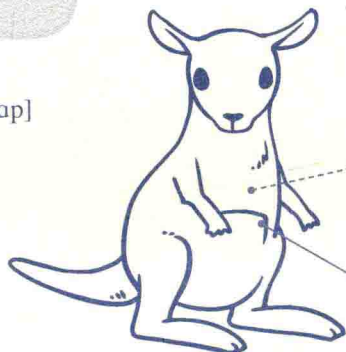

**kangaroo** [ˌkæŋɡəˈruː]  
*n.* 袋鼠

**joey** [ˈdʒɔɪ]  
*n.* 小袋鼠

**pouch** [paʊtʃ]  
*n.* 育儿袋

## hippo

**fat** [fæt]  
*adj.* 肥胖的

**front tooth** [frʌnt tuθ]  
*n.* 前齿

**powerful** [ˈpaʊəfʊl]  
*adj.* 强有力的

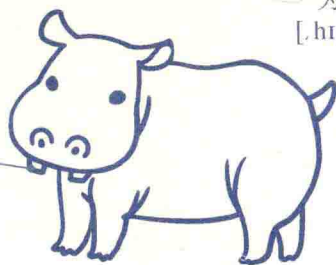

**hippo** [ˈhɪpɒ]  
*n.* 河马  
\* 为 hippopotamus  
[ˌhɪpəˈpɒtəməs] 的简写

**huge** [hjuːdʒ]  
*adj.* 庞大的

## ZOO

**zoo** [zu]  
n. 动物园

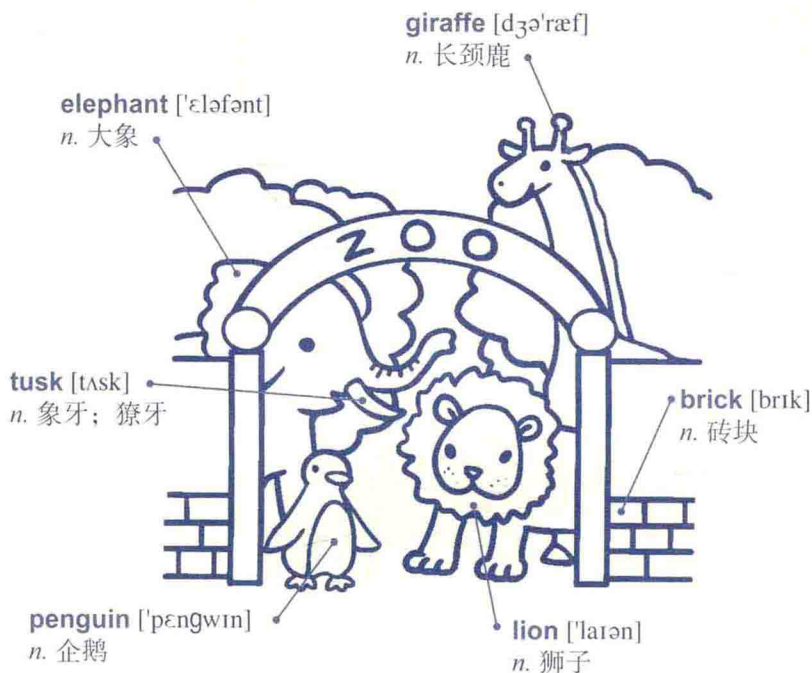

## turtle

**beak** [bɪk]  
n. (螯等的) 喙状嘴

**slow** [sləʊ]  
adj. 龟速的, 缓慢的

**hard** [hɑ:d]  
adj. 坚硬的

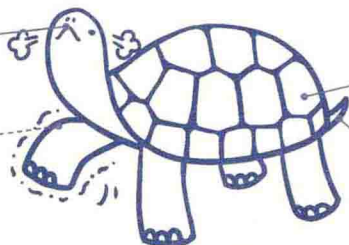

**turtle** ['tɜ:tl]  
n. 海龟

**shell** [ʃɛl]  
n. 甲壳; 果壳

**tail** [teɪl]  
n. 尾巴

**tortoise** ['tɔ:tɔ:s]  
n. 陆龟

## whale

**whale** [hweɪ]

*n.* 鲸鱼

**swim** [swɪm]

*v.* 游

**droplet** ['drɒplɪt]

*n.* 小水滴

**spout** [spaut]

*n.* 水柱

**tail** [teɪl]

*n.* 尾巴

**blowhole** ['bloʊ.hoʊl]

*n.* 喷水孔

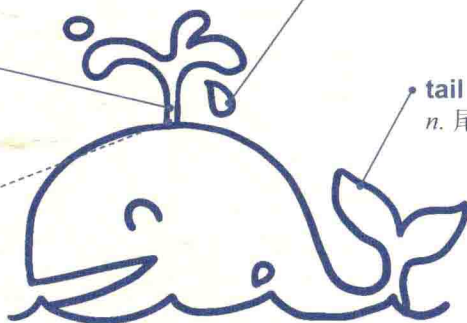

## shark

**shark** [ʃɑ:k]

*n.* 鲨鱼

**scary** ['skəri]

*adj.* 吓人的; 引起惊慌的

**dangerous** ['dendʒərəs]

*adj.* 危险的

**tooth** [tuθ]

*n.* 牙齿

**fin** [fɪn]

*n.* 鱼鳍

**swim** [swɪm]

*v.* 游



\* tooth 的复数形为 teeth [tiθ]

## elephant

snout [snaʊt]

n. 象鼻;  
动物的口鼻

tusk [tʌsk]

n. 象牙; 獠牙

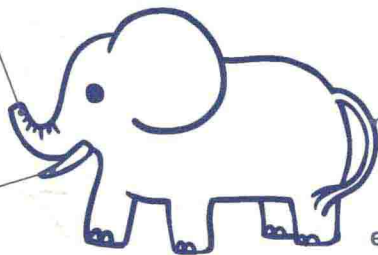

elephant [ˈɛləfənt]

n. 大象

tail [teɪl]

n. 尾巴

enormous [ɪˈnɔːməs]

adj. 庞大的

## rabbit

cage [keɪdʒ]

n. 兽笼

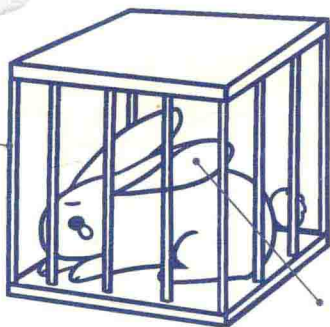

ear [ɪr]

n. 耳朵

rabbit [ˈræbɪt]

n. 兔子

hop [hɒp]

v. 蹦跳

## mouse

tooth [tuːθ]

n. 牙齿

ear [ɪr]

n. 耳朵

paw [pɔː]

n. 脚爪

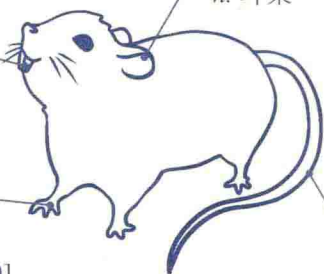

mouse [maʊs]

n. 老鼠

rodent [ˈrɒdənt]

n. 啮齿目动物

tail [teɪl]

n. 尾巴

\* tooth 的复数形为 teeth [tiːθ]



## pig

**oink** [ɔɪŋk]  
v. 猪叫  
n. 猪叫声

**hoof** [huf]  
n. 蹄

**fat** [fæt]  
n. 肥肉

**pig** [pɪg]  
n. 猪

**tail** [tel]  
n. 尾巴

**ham** [hæm]  
n. 火腿

**pork** [pɔ:k]  
n. 猪肉

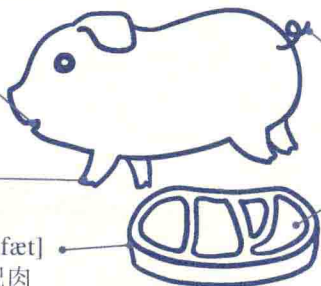

## goose

**feather** ['feðə]  
n. 羽毛

**fowl** [faʊl]  
n. 禽鸟

**neck** [nɛk]  
n. 脖子

**goose** [gus]  
n. 鹅

**quack** [kwæk]  
v. 呱呱叫

**webbed foot** [wɛbd fʊt]  
n. 有蹼的脚

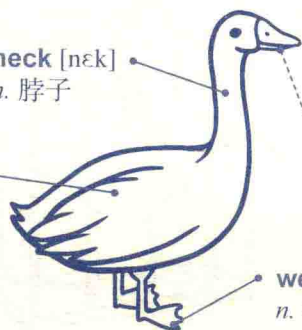

\* goose 的复数形为 geese [gis]

## duck

**mountain** ['maʊntən]  
n. 山

**forest** ['fɒrɪst]  
n. 森林

**stone** [stɒn]  
n. 石块

**lake** [lek]  
n. 湖

**duck** [dʌk]  
n. 鸭子

**quack** [kwæk]  
v. 呱呱叫



## chicken

chicken [ˈtʃɪkɪn]

n. 鸡; 鸡肉

hen [hɛn]

n. 母鸡

beak [bɪk]

n. 喙

mother [ˈmʌðə]

n. 母亲

shake [ʃeɪk]

v. 颤抖

chick [tʃɪk]

n. 小鸡



## bird

bird [bɜːd]

n. 鸟

beak [bɪk]

n. 喙

fly [flaɪ]

v. 飞

feather [ˈfeðə]

n. 羽毛

worm [wɜːm]

n. 虫

wing [wɪŋ]

n. 翅膀

foot [fʊt]

n. 脚

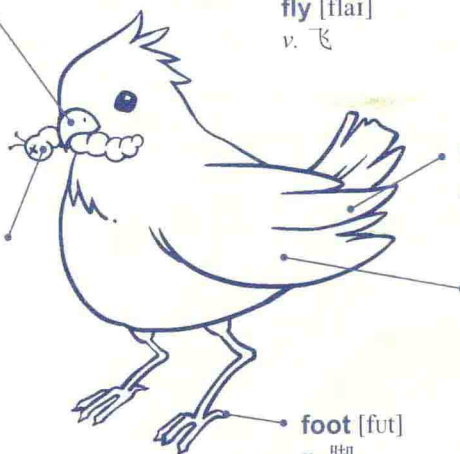

\* foot 的复数形为 feet [fi:t]

## butterfly

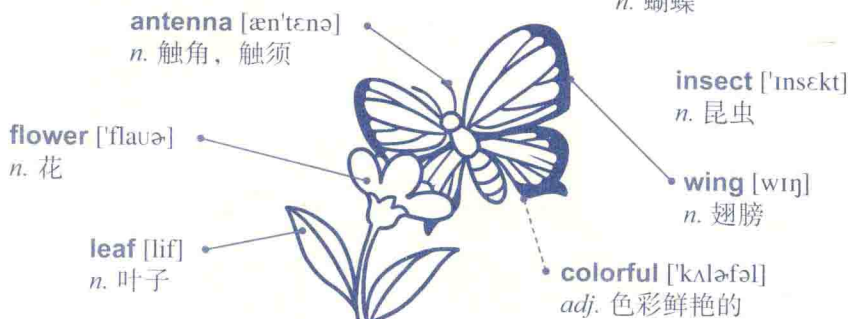

## grasshopper

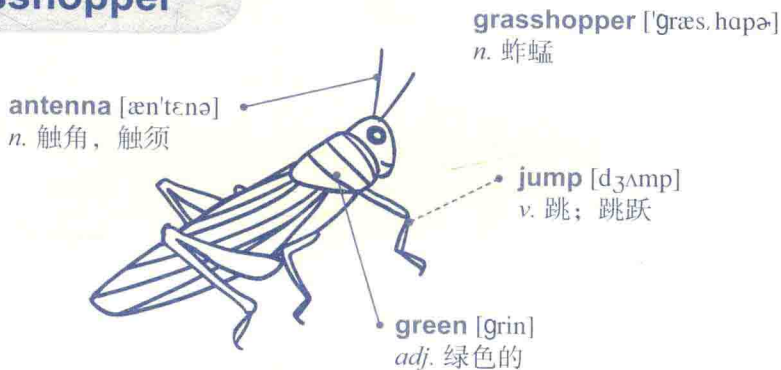

## toad



## bat

**scary** ['skəri]  
adj. 吓人的

**creature** ['kri:tʃə]  
n. 生物; 动物

**animal** ['ænəm]  
n. 动物

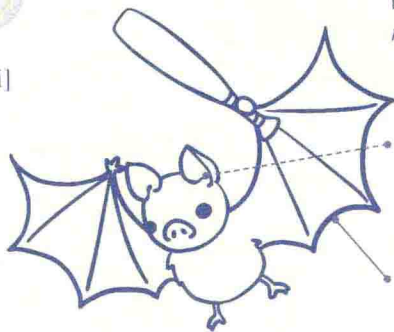

**bat** [bæt]  
n. 蝙蝠; 球棒

**sonar** ['sonɑ:  
n. 声纳

**wing** [wɪŋ]  
n. 翅膀

## bee

**buzz** [bʌz]  
v. 发出嗡嗡声  
n. 嗡嗡声

**honey** ['hʌni]  
n. 蜂蜜

**wing** [wɪŋ]  
n. 翅膀



**bee** [bi:  
n. 蜜蜂

**sting** [stɪŋ]  
n. 螫针  
v. 螫

**fly** [flaɪ]  
v. 飞

## spider

**design** [dɪ'zaɪn]  
n. 图案; 花纹

**silky** ['sɪlki]  
adj. 像丝一般的

**web** [wɛb]  
n. 蜘蛛网

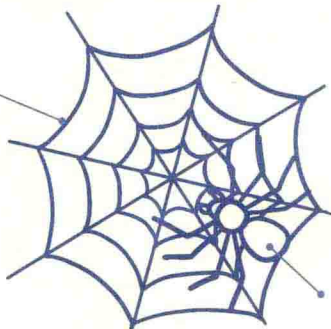

**spider** ['spɪdə]  
n. 蜘蛛

**spin** [spɪn]  
v. 织

**body** ['bɒdi]  
n. 身体

## ant

**ant** [ænt]  
n. 蚂蚁

**antenna** [æn'tenə]  
n. 触角, 触须

**sweet** [swit]  
n. 糖果

**carry** ['kæri]  
v. (用手或肩等) 抱, 扛, 搬

**sugar cube** ['ʃugə kju:b]  
n. 方糖

**leg** [lɛg]  
n. 腿

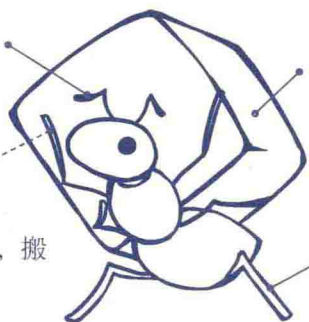

## cicada

**cicada** [sɪ'kədə]  
n. 蝉

**insect** ['ɪnsɛkt]  
n. 昆虫

**imago** [ɪ'meɪɡo]  
n. 成虫

**wind chime**  
[wɪnd tʃaɪm]  
n. 风铃

**trunk** [trʌŋk]  
n. 树干

**summer** ['sʌmə]  
n. 夏天

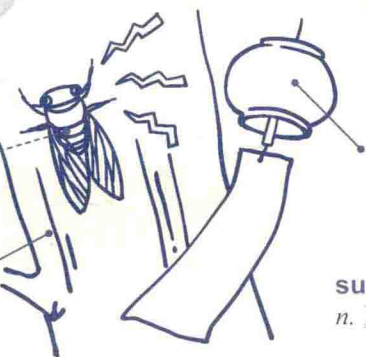

## seed

**seed** [sid]  
n. 种子

**nut** [nʌt]  
n. 坚果

**germ** [dʒɜ:m]  
n. 种子; 胚芽

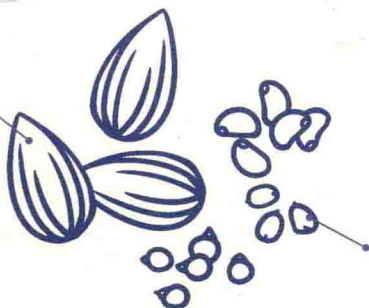

## turnip

**turnip** ['tɜːnɪp]  
n. 萝卜

**struggle** ['strʌɡl]  
v. 努力; 挣扎

**pull** [pʊl]  
v. 拉

**soil** [sɔɪl]  
n. 土壤

**strong** [strɒŋ]  
adj. 强壮的



## plant

**plant** [plænt]  
v. 栽种

**grow** [gro]  
v. 生长

**seed** [sid]  
n. 种子

**mound** [maʊnd]  
n. 土堆

**garden** ['gɑːdn]  
n. 菜园; 花园

**pat** [pæt]  
n. 轻轻拍打

**spade** [speɪd]  
n. 铲



\* grow 的三种时态是 grow/grew/grown

## tree

tree [tri]  
n. 树木

leaf [lif]  
n. 叶子



trunk [trʌŋk]  
n. 树干

\* leaf 的复数形为 leaves [livz]

## bush

bush [buʃ]  
n. 灌木丛

hide [haɪd]  
v. 躲藏

hunt [hʌnt]  
v. 追捕

search [sɜ:tʃ]  
v. 搜寻

sniff [snɪf]  
v. 嗅, 闻

look for [lʊk fɔː]  
ph. 寻找

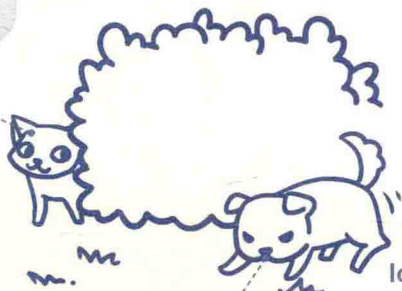

## bean

bean [bi:n]  
n. 豆

soybean ['sɔɪ, bi:n]  
n. 大豆

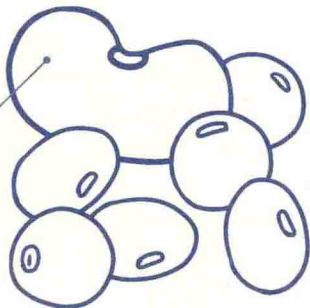

edible ['ɛdəbəl]  
adj. 可食的, 食用的



## rose

rose [roz]  
n. 玫瑰花

bloom [blum]  
v. 绽放

scent [sɛnt]  
n. 香味

leaf [lif]  
n. 叶子

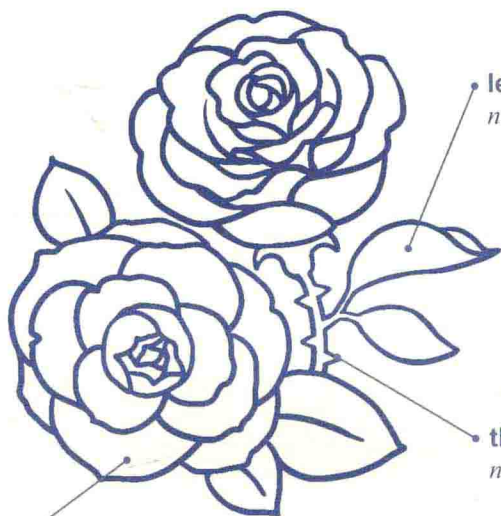

thorn [θɔ:m]  
n. 刺, 棘

petal ['petl]  
n. 花瓣

beautiful ['bjutəfəl]  
adj. 美丽的

## flower

flower ['flaʊə]  
n. 花; 开花植物

tulip ['tjulɪp]  
n. 郁金香



gardener ['gɑ:dənə]  
n. 园丁; 花匠

# Day 4 人与人际关系

- parents
- daughter
- son
- grandfather
- grandmother
- sister
- brother
- twin
- sibling
- teenager
- uncle
- aunt
- housewife
- salesman
- worker
- waiter
- waitress
- cook
- fisherman
- beggar
- author
- teacher
- student
- classmate
- king
- queen
- princess
- prince
- stranger
- officer
- soldier
- accountant
- lawyer
- boss
- policeman
- mailman
- doctor
- dentist
- nurse
- director
- actor
- fan
- friend

## parents

parents ['peərənts]

*n.* 父母亲

\* 若用单数的 parent 则指父亲或母亲其中一人

mother ['mʌðə]

*n.* 母亲

father ['fɑ:ðə]

*n.* 父亲

wife [waɪf]

*n.* 妻子

husband ['hʌzbənd]

*n.* 丈夫

proud [praʊd]

*adj.* 骄傲的; 自豪的

blanket ['blæŋkɪt]

*n.* 毯子

pat [pæt]

*v.* 轻轻拍打

newborn ['nju:.bɔ:rn]

*n.* 新生儿

hold [həʊld]

*v.* 抱住



## daughter

daughter ['dɔ:tə]

*n.* 女儿

classroom ['klæs.rʊm]

*n.* 教室

mother ['mʌðə]

*n.* 母亲

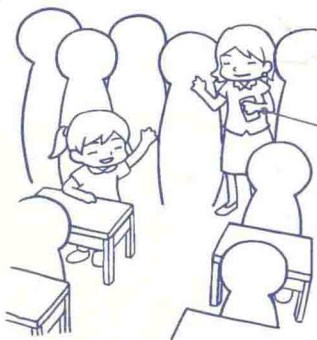

## son

**father** ['fɑðə]  
n. 父亲

**camera** ['kæməɹə]  
n. 照相机

**photograph** ['fotə.ɡræf]  
v. 拍照

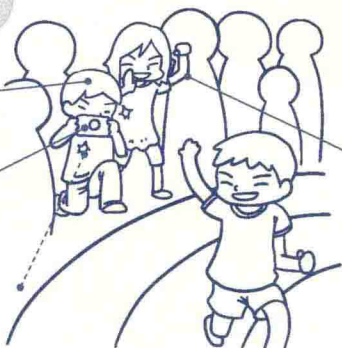

**son** [sʌn]  
n. 儿子

**mother** ['mʌðə]  
n. 母亲

## grandfather

**elderly** ['eldəli]  
adj. 上了年纪的

**goatee** [ɡo'ti]  
n. 山羊胡

**cane** [ken]  
n. 拐杖



**grandfather** ['grænd.fɑðə]  
n. 祖父; 外祖父

**wrinkle** ['rɪŋkl]  
n. 皱纹

**old** [old]  
adj. 老的

## grandmother

**peaceful** ['pi:sfəl]  
adj. 祥和的

**gentle** ['dʒɛntl]  
adj. 和蔼的

**fur** [fɜ:  
n. 皮毛



**grandmother** ['grænd.mʌðə]  
n. 祖母; 外祖母

**cat** [kæt]  
n. 猫

**pet** [pɛt]  
n. 宠物

**paw** [pɔ:  
n. 脚爪

## sister

**dress** [drɛs]

*n.* 连身裙

**hold** [hold]

*v.* 握住

\* **hold hands** 牵手



**sister** ['sɪstə]

*n.* 姐妹

**girl** [gɜ:l]

*n.* 姑娘, 少女

**happy** ['hæpi]

*adj.* 开心的

## brother

**pose** [poz]

*v.* 摆姿势

**play** [ple]

*v.* 玩耍; 笑闹



**brother** ['brʌðə]

*n.* 兄弟

**hug** [hʌg]

*v.* 紧抱; 拥抱

## twin

**identical** [aɪ'dentɪkəl]

*adj.* 如出一辙的;  
一模一样的

**pattern** ['pætə:n]

*n.* 花样; 图案



**twin** [twɪn]

*n.* 双胞胎

**sister** ['sɪstə]

*n.* 姐妹

**spot** [spɒt]

*n.* 斑点

## sibling

sibling ['sɪblɪŋ]

n. 兄弟姐妹

playful ['pleɪfəl]

adj. 嬉戏的

playtime ['pleɪ.taɪm]

n. 游戏时间; 娱乐时间

excited [ɪk'saɪtɪd]

adj. 兴奋的

loud [laʊd]

adj. 大声的



group [gru:p]

n. 群

cousin ['kʌzən]

n. 堂 / 表兄弟姐妹

## teenager

teenager ['ti:n.edʒə]

n. 青少年

bag [bæg]

n. 提袋

student ['stju:dənt]

n. 学生

handsome ['hænsəm]

adj. 英俊的

jacket ['dʒæki:t]

n. 夹克

carry ['kæri]

v. (用手、肩等) 抱

button ['bʌtən]

n. 钮扣





## uncle

**suit** [sut]  
*n.* 西装; 套装



**uncle** ['ʌŋkəl]  
*n.* 伯伯; 叔叔; 姑夫;  
姨夫; 舅舅

**necktie** ['nek.taɪ]  
*n.* 领带

## aunt

**kind** [kaɪnd]  
*adj.* 亲切的



**aunt** [ænt]  
*n.* 伯母; 婶婶; 姑姑;  
阿姨; 舅妈

**apron** ['eprən]  
*n.* 围裙

## housewife

**soup spoon**  
[sup spun]  
*n.* 汤勺

**apron** ['eprən]  
*n.* 围裙



**housewife** ['haus.waɪf]  
*n.* 家庭主妇

**handkerchief** ['hæŋkə.tʃɪf]  
*n.* 手帕

**cloth** [klɒθ]  
*n.* 抹布

**hardworking** [ˌhɑ:d'wɜ:kɪŋ]  
*adj.* 努力工作的



## salesman

salesman ['selzmən]

n. 业务员

smile [smaɪl]

v. 微笑

wipe [waɪp]

v. 抹; 擦拭



cloth [klɒθ]

n. 抹布

spray [spreɪ]

v. 喷

bottle ['bɒtl]

n. 瓶子

## worker

worker ['wɜ:kə]

n. 工人

hard hat [hɑ:d hæʔ]

n. 工地安全帽

gravel ['grævəl]

n. 碎石

pick [pɪk]

n. 丁字镐

strike [straɪk]

v. 敲打



## waiter

**waiter** ['wetə]  
n. 男服务生

**bow tie** [bo taɪ]  
n. 领结

**serve** [sɜ:v]  
v. 为……服务

**direct** [dɪ'rekt]  
v. 指引方向

**towel** ['taʊəl]  
n. 毛巾

\* waiter 如今已男女通用



## waitress

**waitress** ['wetris]  
n. 女服务生

**server** ['sɜ:və]  
n. 服务者；上菜者

**female** ['fi:mel]  
adj. 女的

**carry** ['kæri]  
v. 托、搬

**hold** [hold]  
v. 端着

**bow tie** [bo taɪ]  
n. 领结

**uniform** ['ju:nə.fɔ:m]  
n. 制服

**apron** ['eprən]  
n. 围裙；工作裙



## cook

**cuisine** [kwi'zi:n]  
n. 烹饪法

**ladle** ['ledl]  
n. 长柄勺

**apron** ['eprən]  
n. 围裙; 工作裙



**cook** [kuk]  
n. 厨师

**chef's hat** [ʃɛfs hæ:t]  
n. 厨师帽

**chef** [ʃɛf]  
n. 主厨

## fisherman

**fisherman** ['fɪʃəmən]  
n. 渔夫

**pull** [pul]  
v. 拉, 拽



**boat** [bot]  
n. 小船

**catch** [kætʃ]  
v. 抓住

**net** [nɛt]  
n. 鱼网

## beggar

**beggar** ['bɛgə]  
n. 乞丐

**poor** [pʊr]  
adj. 贫穷的

**beg** [bɛg]  
v. 乞讨

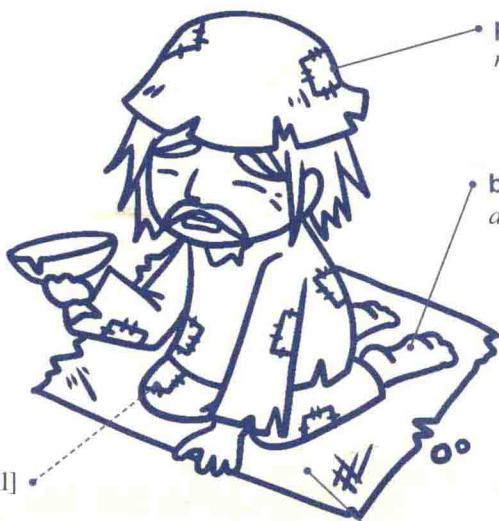

**patch** [pætʃ]  
n. 补丁

**barefoot** ['bɛr. fʊt]  
adj. 光着脚的

**kneel** [ni:l]  
v. 跪下

**mat** [mæt]  
n. 草席; 脚踏垫

**homeless** ['hɒmlɪs]  
adj. 无家可归的

## author

**author** ['ɔθə]  
n. 作家

**ink** [ɪŋk]  
n. 墨水

**glasses** ['glæsɪz]  
n. 眼镜

**manuscript** ['mæn.jə. skript]  
n. 原稿

**script** [skript]  
n. 手迹; 手写体



## teacher

**press** [prɛs]  
v. 推; 挤

**headache** ['hɛd.ek]  
n. 头痛

**tired** [taɪrd]  
adj. 疲倦的

**elbow** ['ɛlbo]  
n. 手肘



**teacher** ['titʃə]  
n. 老师, 教师

**arm** [ɑ:m]  
n. 手臂

**serious** ['sɪriəs]  
adj. 严肃的

## student

**raise** [reɪz]  
v. 举起



**elementary school**  
[.ɛlɪ'mɛntəri skul]  
n. 小学

**student** ['stju:dənt]  
n. 学生

**pupil** ['pjʊpəl]  
n. 学生; 小学生

**answer** ['ænsə]  
v. 回答

**knowledgeable** ['nɒlɪdʒəbəl]  
adj. 知识渊博的

## classmate

**pigtail** ['pɪg.tel]  
n. 辫子

**textbook** ['tɛkst.bʊk]  
n. 课本

**conversation** [ˌkɒnvə'seɪʃən]  
n. 谈话



**classmate** ['klæs.met]  
n. 同班同学

**friend** [frɛnd]  
n. 朋友, 友人

**carry** ['kæri]  
v. 抱, 提

## king



## queen



## princess

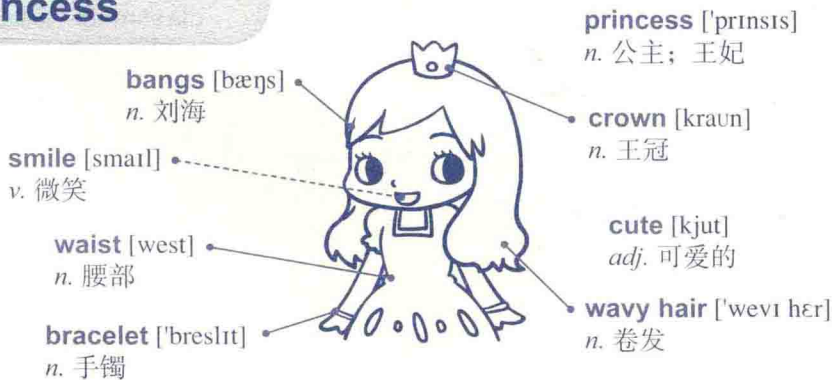



## prince

**cape** [keɪp]  
n. 斗篷

**handsome** ['hænsəm]  
adj. 英俊的

**sword** [sɔ:d]  
n. 剑



**prince** [prɪns]  
n. 王子; 亲王

**brave** [breɪv]  
adj. 勇敢的

**glove** [glɒv]  
n. 手套

## stranger

**foreigner** ['fɔ:rnə]  
n. 外国人

**question** ['kwɛstʃən]  
n. 问题; 询问

**arrow** ['ærə]  
n. 箭头

**direction** [dɪ'rekʃən]  
n. 方向

**finger** ['fɪŋgə]  
n. 手指 (大拇指以外的)

**thumb** [θʌm]  
n. 大拇指

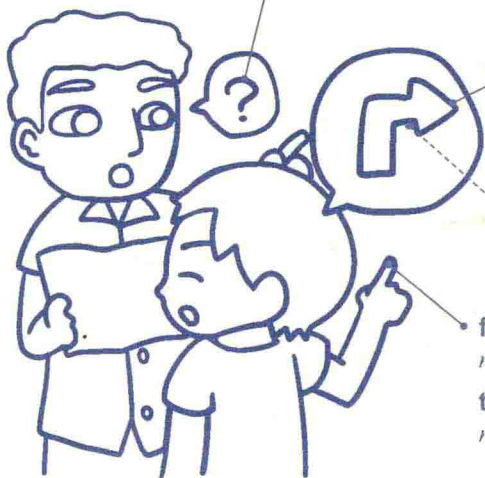

**alien** ['eɪlɪən]  
adj. 外国的

**point** [pɔɪnt]  
v. 指出



## officer

**superior** [sə'piəriə]  
*n.* 长官; 上级

**troop** [tru:p]  
*n.* 军队

**military** ['mɪlə,təri]  
*adj.* 军事的; 军用的

**salute** [sə'lut]  
*v.* 敬礼



**officer** ['ɒfəsə]  
*n.* 军官

**soldier** ['sɒldʒə]  
*n.* 士兵

**uniform** ['jʊnə,fɔ:m]  
*n.* 制服

**sergeant** ['sɑ:dʒənt]  
*n.* 中士

## soldier

**camouflage** ['kæməflɑ:ʒ]  
*n.* 迷彩; 伪装

**army** ['ɑ:mi]  
*n.* 军队

**machine gun** [mə'ʃɪn ɡʌn]  
*n.* 机关枪

**helmet** ['helmit]  
*n.* 头盔; 安全帽



**captain** ['kæptɪn]  
*n.* 陆军上尉; 海军上校; 空军上尉

**colonel** ['kɒnl]  
*n.* 陆军上校

**lieutenant** [lu'tenənt]  
*n.* 中尉; 少尉

**pocket** ['pɑ:kɪt]  
*n.* 口袋

## accountant

**serious** ['sɪrɪəs]  
adj. 认真的



**accountant** [ə'kaʊntənt]  
n. 会计师; 会计人员

**calculate** ['kælkjə.let]  
v. 计算

**check** [tʃek]  
n. 支票  
v. 检查

## lawyer

**court** [kɔ:t]  
n. 法院

**law** [lɔ:]  
n. 法律

**courtroom** ['kɔ:t.rʊm]  
n. 法庭; 审判室



**lawyer** ['lɔ:jə-]  
n. 律师; 法务人员

**attorney** [ə'tɜ:nɪ]  
n. 律师

## boss

**work** [wɜ:k]  
n. 工作

**suit** [su:t]  
n. 套装; 西装

**job** [dʒɒb]  
n. 职业



**boss** [bɒs]  
n. 老板; 上司

**office** ['ɒfɪs]  
n. 办公室

**secretary** ['sekɾə.teri]  
n. 秘书

**file** [faɪl]  
n. 文件, 资料夹

## policeman

box office ['bɒks.ɒfɪs]

*n.* 售票处

cop [kɒp]

*n.* [口] 警察

policeman [pə'li:mən]

*n.* 警察

scalper ['skælpə]

*n.* 倒票者; 卖黄牛票的人

ticket ['tɪkɪt]

*n.* 票券

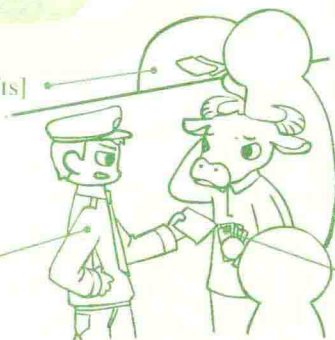

## mailman

messenger ['mesəndʒə]

*n.* 送信人; 邮递员

courier ['kʊriə]

*n.* 快递员

mailman ['meɪl.mæn]

*n.* 邮差; 邮递员

deliver [dɪ'livə]

*v.* 投递

album ['ælbəm]

*n.* 集邮簿

letter ['letə]

*n.* 信

strap [stræp]

*n.* 带子

postage ['pɒstɪdʒ]

*n.* 邮资

zip code [zɪp kɒd]

*n.* 邮政编码

mailbox ['meɪl.bɒks]

*n.* 邮筒

post office [pɒst 'ɒfɪs]

*n.* 邮局

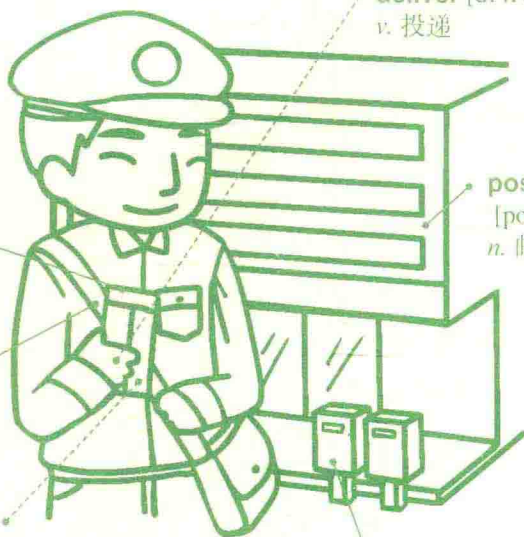

## doctor

**earpiece** ['ɪrɪpiːs]  
n. 耳机

**checkup** ['tʃek.ʌp]  
n. 检查



**doctor** ['dɒktə]  
n. 医生

**stethoscope** ['stetθə.skop]  
n. 听诊器

**examine** [ɪg'zæmɪn]  
v. 检查; 诊疗

## dentist

**drill** [drɪl]  
n. 钻牙机; 钻头

**cord** [kɔːd]  
n. 粗线; 索



**dentist** ['dentɪst]  
n. 牙医

**mask** [mæsk]  
n. 口罩

**false teeth** [fɔːls tiθ]  
n. 假牙

## nurse

**fever** ['fɪvə]  
n. 发烧

**illness** ['ɪlnɪs]  
n. 身体不舒服; 生病



**nurse** [nɜːs]  
n. 护士

**cross** [krɒs]  
n. 十字形

**rail** [reɪl]  
n. 围栏; 栏杆

**sick** [sɪk]  
adj. 生病的

## director



**director** [dɪ'rektə]

*n.* 导演

**paparazzi** ['pəpə.rɑtsɪ]

*n.* 狗仔队

**journalist** ['dʒɜːnəlɪst]

*n.* 新闻工作者

**reporter** [rɪ'pɔːtə]

*n.* 记者

\* paparazzi 单数形式为 paparazzo [ˌpəpə'rɑtsɔ]

## actor

**popular** ['pɒpjələ]

*adj.* 受欢迎的

**famous** ['feməs]

*adj.* 著名的

**celebrity** [sɪ'leɪbrəti]

*n.* 名人, 名流



**actor** ['æktə]

*n.* (男或女) 演员

**actress** ['æktɪs]

*n.* 女演员

**wave** [weɪv]

*v.* 挥手

**fan** [fæn]

*n.* 爱慕者, 粉丝

## fan

fan [fæn]  
n. 扇子

support [sə'pɔ:t]  
v. 支持

supporter [sə'pɔ:tə]  
n. 支持者

scream [skri:m]  
v. 尖叫

yell [jɛ:l]  
v. 叫喊

fan [fæn]  
n. 爱慕者, 粉丝

cheer [tʃi:r]  
n. 欢呼, 喝采



## friend

upset [ʌp'set]  
adj. 心烦的

unhappy [ʌn'hæpi]  
adj. 不愉快的

cry [krai]  
v. 哭; 叫喊

friend [frɛnd]  
n. 朋友



worm [wɜ:m]  
n. 毛毛虫

# Day 5 场所与交通工具

- market
- bakery
- supermarket
- department store
- gift shop
- bookstore
- library
- academy
- elementary school
- stadium
- recreation center
- gym
- restaurant
- hotel
- museum
- theater
- hospital
- temple
- church
- castle
- park
- playground
- countryside
- town
- city
- farm
- factory
- station
- train
- MRT
- bus
- bus stop
- highway
- sidewalk
- vehicle
- taxi
- truck
- bicycle
- motorcycle
- scooter
- rowboat
- boat
- ship
- airplane
- airport
- earth



## market

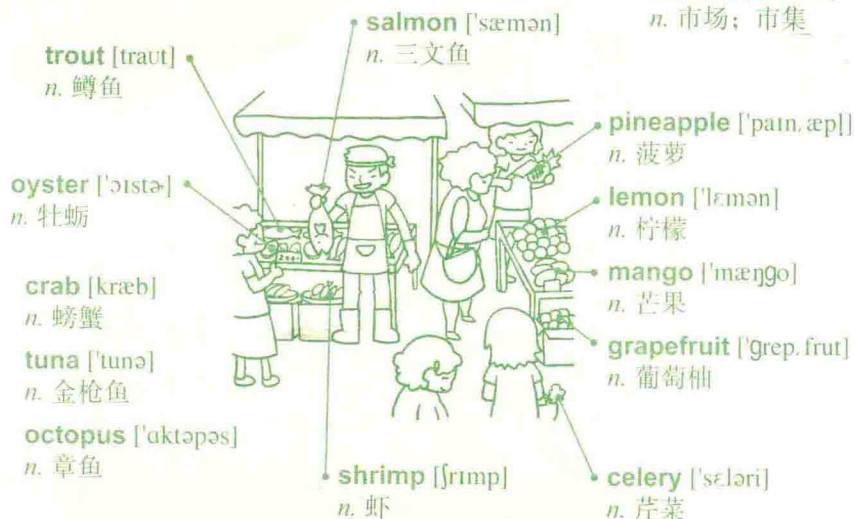

## bakery

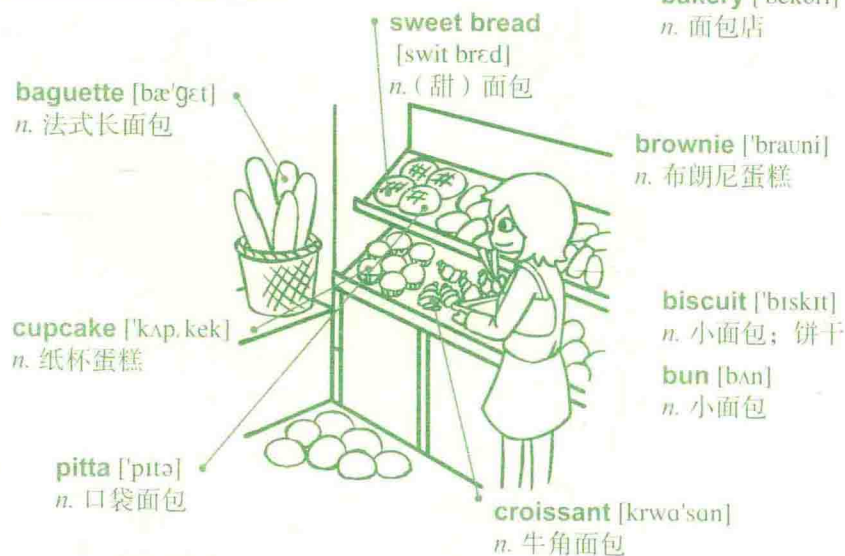

## supermarket

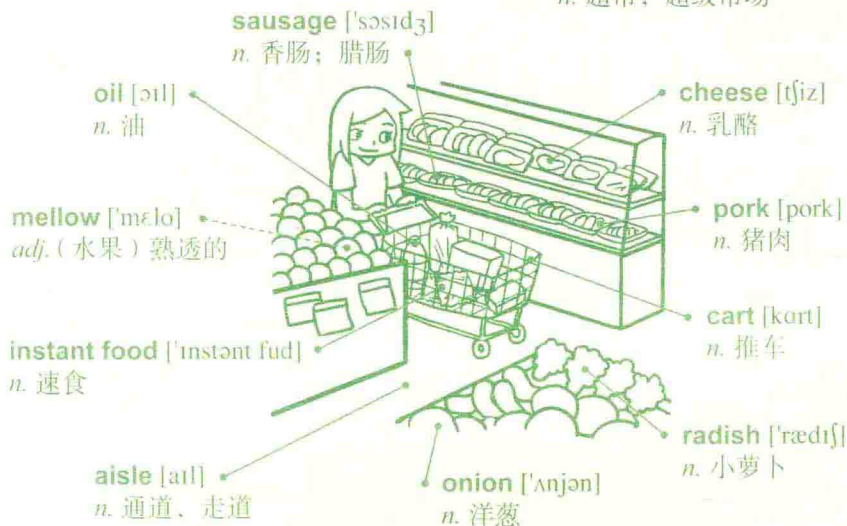

**supermarket** ['supə, mɑ:kɪt]  
*n.* 超市, 超级市场

## department store

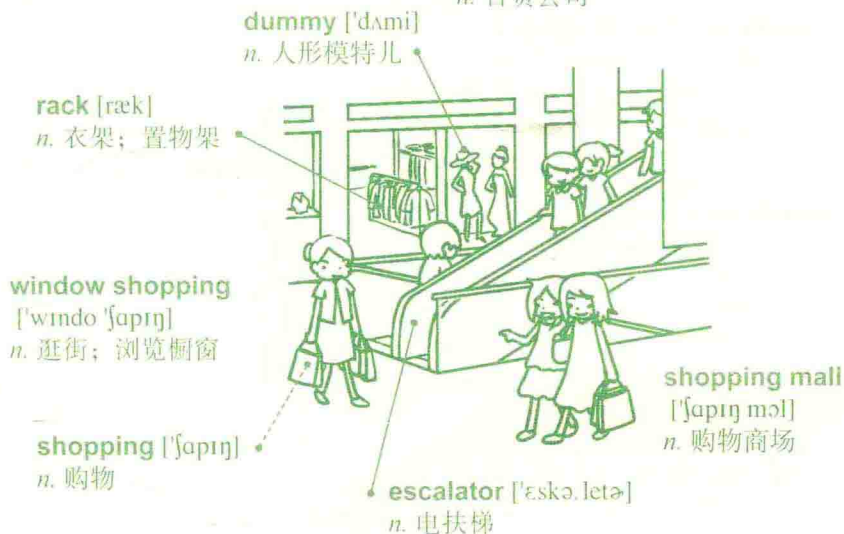

**department store** [dɪ'pɑ:tmənt stɔ:]  
*n.* 百货公司

## gift shop

**salesperson** ['selz.pə'sən]  
n. 店员, 售货员

**stuffed animal** [stʌft 'ænəmə]  
n. 填充玩具

**cash register**  
[kæʃ 'rɛdʒɪstə]  
n. 收银机

**gift-wrapped**  
['gɪft.ræpt]  
adj. (将商品做)  
礼物包装的

**purchase** ['pɜ:tʃəs]  
v. 购买

**tag** [tæg]  
n. 标签; 货签

**customer** ['kʌstəmə]  
n. 顾客

**price tag** [praɪs tæg]  
n. 价格标签



## bookstore

**dictionary** ['dɪkʃən.ɛrɪ]  
n. 辞典

**bookstore** ['buk.stɔ:  
n. 书店

**shelf** [ʃelf]  
n. (书柜等的)  
架子; 隔板

**novel** ['nɒvəl]  
n. 长篇小说

**fiction** ['fɪkʃən]  
n. 小说

**bestseller**  
[.best'sɛlə]  
n. 畅销书

**comic book**  
['kɒmɪk buk]  
n. 漫画书

**encyclopedia** [ɪn.sai'klə'pɪdɪə]  
n. 百科全书

**magazine** [ˌmæɡə'zɪn]  
n. 杂志, 期刊



## library

**bookcase** ['buk. kes]  
n. 书架

**read** [ri:d]  
v. 读

**reader** ['ri:də]  
n. 读者

**table** ['teb]  
n. 桌子

**aisle** [aɪl]  
n. 走道

**library** ['laɪ. brəri]  
n. 图书馆

**shelf** [ʃelf]  
n. 隔板

**book** [buk]  
n. 书籍  
v. 预约

## academy

**teach** [ti:t]  
v. 教, 讲授

**blackboard** ['blæk. bɔ:d]  
n. 黑板

**professor** [prə'fesə]  
n. 教授

**academy** [ə'kædəmi]  
n. (技术) 学院

**university** [ˌju:nə'vɜ:səti]  
n. 大学

**college** ['kɒlɪdʒ]  
n. (专科) 学院

**undergraduate** [ˌʌndə'grædʒuət]  
n. 大学生

**freshman** ['frefʃmən]  
n. 大一新生

## elementary school

**building** ['bɪldɪŋ]  
n. 建筑物

**freshman** ['frefʃmən]  
n. 一年级新生

**elementary school**  
[ˌelə'mentəri skul]  
n. 小学

**hat** [hæt]  
n. 帽子

**hedge** [hedʒ]  
n. 树篱

## stadium

**field** [fild]  
n. 打棒球的场地；外场

**infield** ['in.fild]  
n. 内场

**inning** ['ɪnɪŋ]  
n. 局（棒球的某一局）

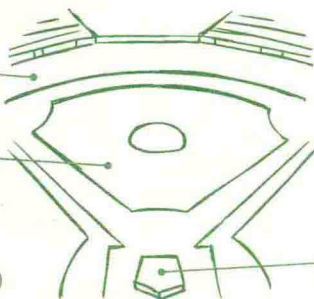

**stadium** ['stediəm]  
n. 体育场

**home run** [hɒm rʌn]  
n. 全垒打

**grand slam**  
[grænd slæm]  
n. 满贯全垒打

**base** [bes]  
n. 垒

## recreation center

**curtain** ['kɜ:tən]  
n. 幕布

**stage** [steɪdʒ]  
n. 舞台

**court** [kɔ:t]  
n. 球场

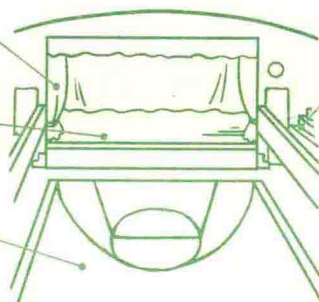

**recreation center**  
[ˌrekrei'eɪʃən 'sentə]  
n. 娱乐中心

**auditorium** [ˌɔ:də'tɔ:riəm]  
n. 观众席

**gym** [dʒɪm]  
n. (学校里的) 体育馆；健身房

## gym

**treadmill** ['treɪd.mɪl]  
n. 跑步机

**barbell** ['bɑ:berl]  
n. 杠铃

**exercise** ['eksə.saɪz]  
n. 运动；锻炼

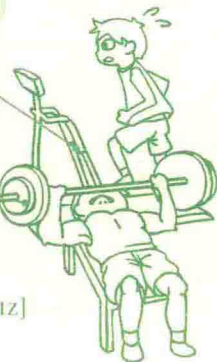

**gym** [dʒɪm]  
n. 健身房  
\* 是gymnasium  
[dʒɪm'neɪziəm] 的  
简写

## restaurant

**restaurant** ['rɛstərənt]

*n.* 餐厅

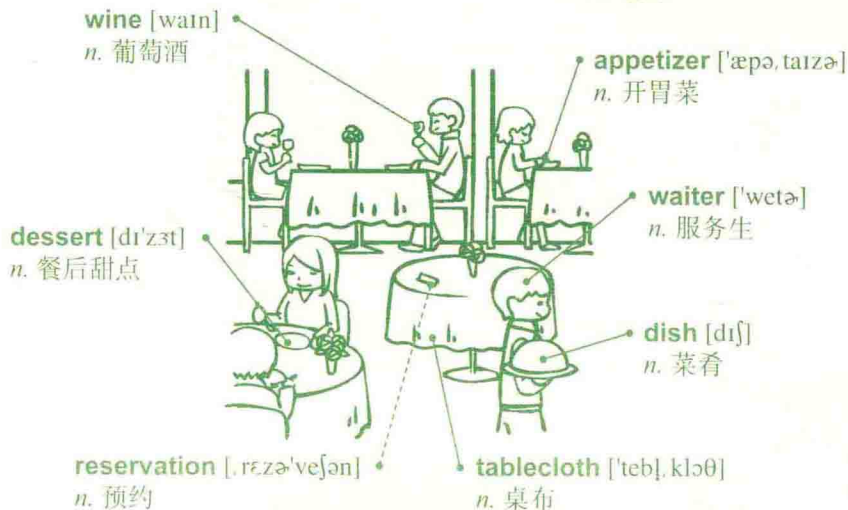

## hotel

**hotel** [ho'tel]

*n.* 旅馆

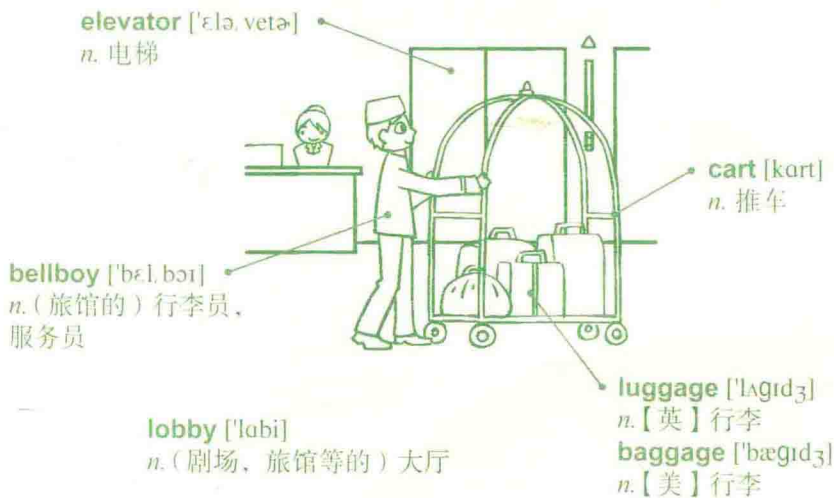



## museum

**ceramic** [sə'remɪk]  
adj. 陶瓷的

**display** [dɪ'spleɪ]  
v. 陈列; 展示

**vase** [ves]  
n. 花瓶

**museum** [mju:'ziəm]  
n. 博物馆

**scroll** [skrol]  
n. 画卷

**visitor** ['vɪzɪtə]  
n. 参访者

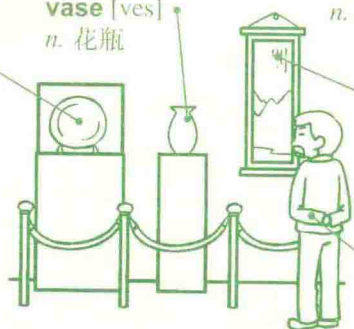

## theater

**movie** ['muvi]  
n. 电影

**cinema** ['sɪnəmə]  
n. 【英】电影院

**sign** [saɪn]  
n. 告示

**theater** ['θiətə]  
n. 电影院

**billboard** ['bɪl.bɔ:d]  
n. 广告看板

**box office** [bɒks 'ɒfɪs]  
n. 售票处

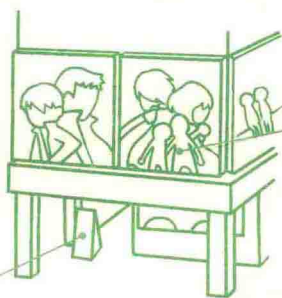

## hospital

**building** ['bɪldɪŋ]  
n. 建筑物

**operate** ['ɒpə.reɪt]  
v. 开刀

**emergency** [ɪ'mɛdʒənsɪ]  
n. 急诊室

**hospital** ['hɒspɪtəl]  
n. 医院

**surgery** ['sɜ:dʒəri]  
n. 外科

**hedge** [hedʒ]  
n. 树篱

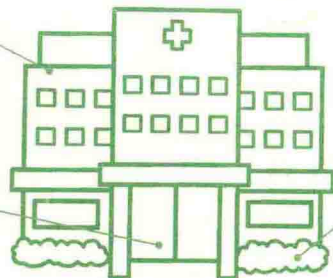



## temple

**religion** [rɪ'lɪdʒən]  
n. 宗教

**worship** ['wɜːʃɪp]  
n. 敬神



**temple** ['tɛmpəl]  
n. 庙宇

**pillar** ['pɪlə]  
n. 柱子

## church

**cross** [krɒs]  
n. 十字架; 十字形

**choir** [kwɔɪr]  
n. (教堂的) 唱诗班



**tower** ['taʊə]  
n. 塔楼

**church** [tʃɜːtʃ]  
n. 教堂, 礼拜堂

**religion** [rɪ'lɪdʒən]  
n. 宗教

**religious** [rɪ'lɪdʒəs]  
adj. 宗教的

## castle

**flag** [flæɡ]  
n. 旗帜

**entrance** ['ɛntrəns]  
n. 入口

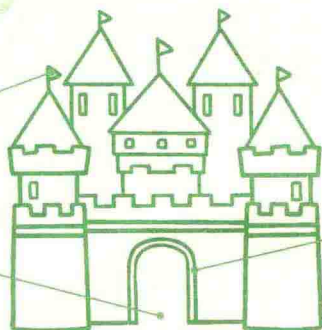

**castle** ['kæsl]  
n. 城堡

**arch** [ɑːtʃ]  
n. 拱门

## park

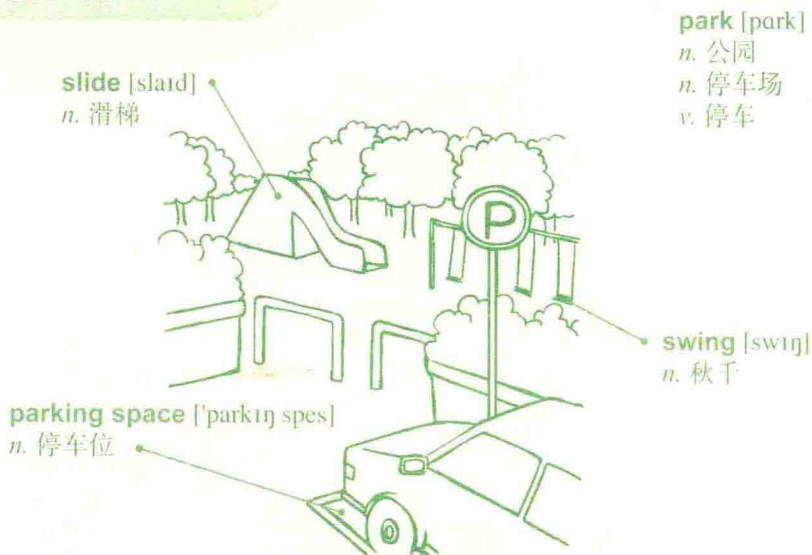

**park** [pɑ:k]  
n. 公园  
n. 停车场  
v. 停车

## playground

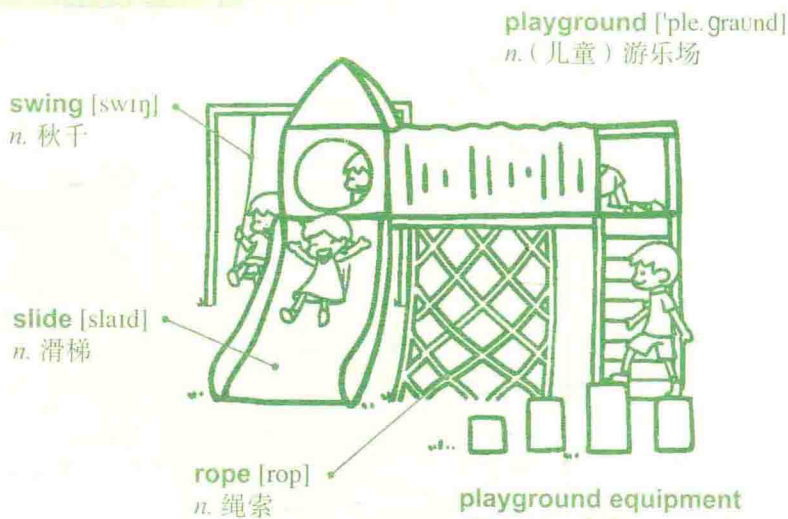

**playground** ['pleɪgraʊnd]  
n. (儿童) 游乐场

**playground equipment**  
['pleɪgraʊnd r'kwɪpmənt]  
n. 游乐器材

## countryside

**countryside** ['kʌntri, saɪd]

*n.* 乡间; 农村

**field** [fi:ld]

*n.* 原野

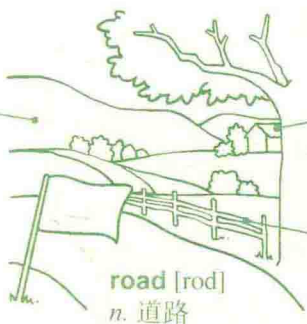

**barn** [bɑ:n]

*n.* 谷仓

**fence** [fɛns]

*n.* 栅栏

**road** [rɔ:d]

*n.* 道路

## town

**town** [taʊn]

*n.* 市镇

**balloon** [bə'lʊn]

*n.* 气球

**fountain** ['faʊntɪn]

*n.* 喷泉

**square** [skwɛr]

*n.* 广场

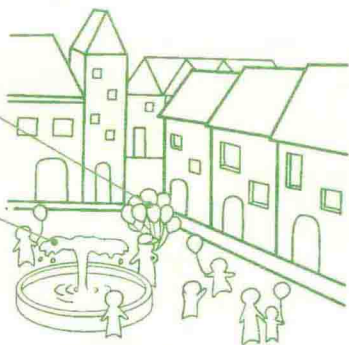

## city

**skyscraper** ['skaɪ, skreɪpə]

*n.* 摩天大楼

**city** ['sɪti]

*n.* 都市

**mansion** ['mænjən]

*n.* 大厦

**boulevard** ['bulə, vɑ:d]

*n.* 林荫大道

**avenue** ['ævə, nju]

*n.* 大街

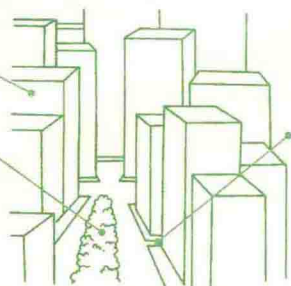

**block** [blɒk]

*n.* 街区

## farm

**farm** [fɑ:m]

*n.* 农场

**countryside** ['kʌntri, saɪd]

*n.* 农村; 乡间

**barn** [bɑ:n]

*n.* 谷仓, 粮仓

**fence** [fɛns]

*n.* 栅栏

**pitchfork** ['pɪtʃ, fɔ:k]

*n.* 干草叉

**farmer** ['fɑ:mə]

*n.* 农夫; 农场经营者

**overalls** ['ovə, əls]

*n.* 工装裤



## factory

**factory** ['fæktəri]

*n.* 工厂

**pollution** [pə'luʃən]

*n.* 污染

**pollute** [pə'lut]

*v.* 污染

**smoke** [smok]

*n.* 烟

**hard hat** [hɑ:d hæt]

*n.* 工地安全帽

**blueprint** ['blu, prɪnt]

*n.* 蓝图; 设计图



## station

roof [ru:f]  
n. 屋顶

entrance ['entrəns]  
n. 入口

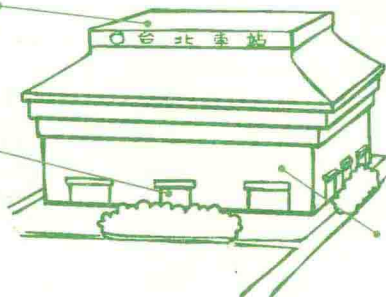

station ['steɪʃən]  
n. 车站

building ['bɪldɪŋ]  
n. 建筑物

## train

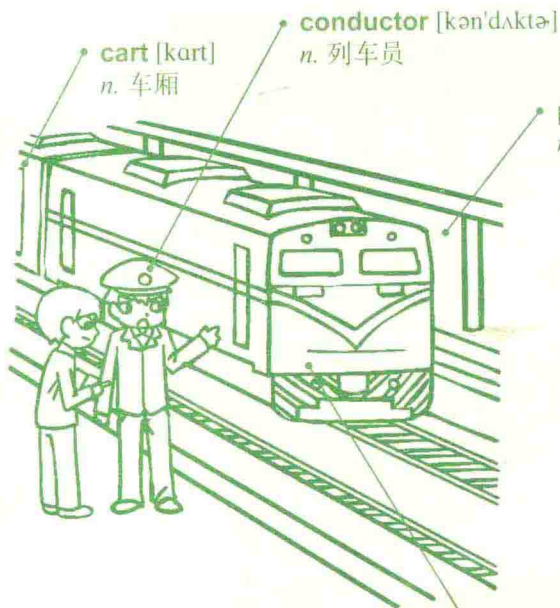

cart [kɑ:t]  
n. 车厢

conductor [kən'dʌktə]  
n. 列车员

platform ['plæt.fɔ:m]  
n. 月台

railroad ['reɪ.ləd]  
n. 铁路

locomotive [ˌləkə'motɪv]  
n. 火车头

## MRT

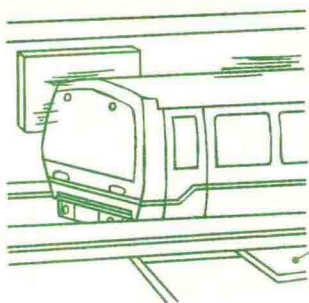

### MRT

*n.* 大众捷运系统  
(= Mass Rapid Transit  
[mæs 'ræpɪd 'trænsɪt])

### subway ['sʌb, we]

*n.* 地铁

### platform ['plæt, fɔ:m]

*n.* 月台

## bus

### bus stop [bʌs stɒp]

*n.* 公交车站

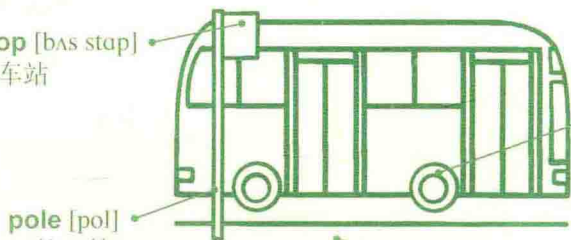

**pole** [pɒl]  
*n.* 柱; 竿

### bus [bʌs]

*n.* 公交车

### tire [taɪr]

*n.* 轮胎

### sidewalk ['saɪd, wɔ:k]

*n.* 人行道

## bus stop

### sign [saɪn]

*n.* 标志

### wait [weɪ]

*v.* 等候

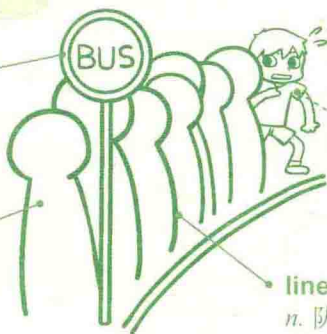

### bus stop [bʌs stɒp]

*n.* 公交车站

### worried ['wɜ:riɪd]

*adj.* 担心的

### line [laɪn]

*n.* 队伍

# highway

**traffic** ['træfɪk]  
n. 交通

**speed** [spi:d]  
n. 速度  
v. 加速

**freeway** ['fri:weɪ]  
n. 高速公路

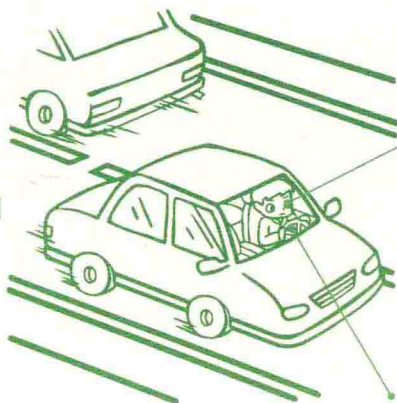

**highway** ['haɪ. weɪ]  
n. 公路

**driver** ['draɪvə]  
n. 驾驶员

**drive** [draɪv]  
v. 驾驶

**steering wheel**  
['stɪərɪŋ hwil]  
n. 方向盘

# sidewalk

**sidewalk** ['saɪd. wɔ:k]  
n. 人行道

**parked** [pɑ:kɪd]  
adj. 已停放好的

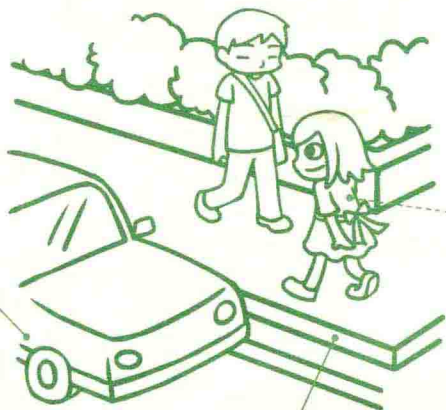

**pass** [pæs]  
v. 经过

**curb** [kɜ:b]  
n. (人行道的) 路缘



## vehicle

**vehicle** ['vi:kəl]

*n.* 车辆

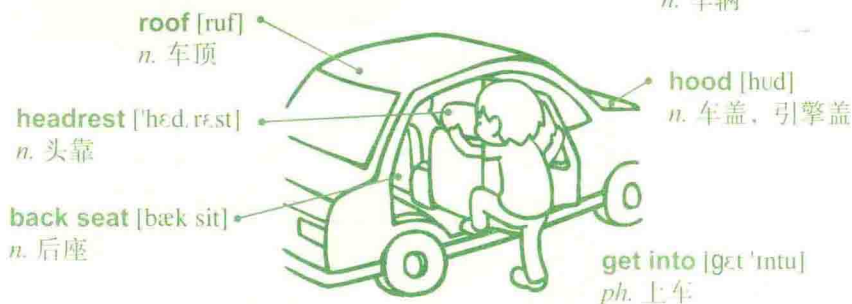

## taxi

**taxi** ['tæksi]

*n.* 出租车

**taxicab** ['tæksi,kæb]

*n.* 出租车



## truck

**truck** [trʌk]

*n.* 卡车



## bicycle

bicycle ['baɪsɪkl̩]

n. 自行车



## motorcycle

motorcycle [ˈmɒtəˌsaɪkl̩]

n. 摩托车

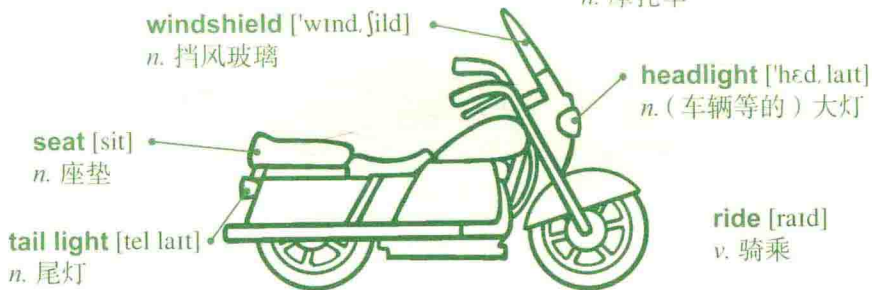

## scooter

scooter [ˈskuːtə]

n. 小型摩托车



## rowboat

**rowboat** ['ro. bot]

*n.* (用桨划动的) 船, 小艇

**cloud** [klaud]

*n.* 云

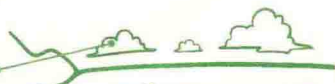

**wave** [wev]

*n.* 浪, 波浪



**beach** [bit]

*n.* 海滩; 海滨度假地



**oar** [or]

*n.* 桨



## boat

**boat** [bot]

*n.* 船

**shore** [ʃor]

*n.* 岸, 滨

**coast** [kɔst]

*n.* 海岸

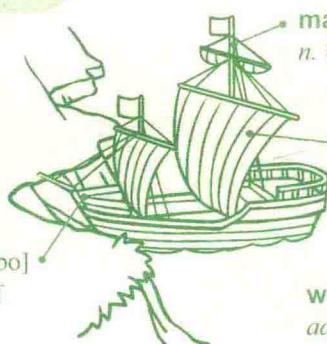

**mast** [mæst]

*n.* 桅杆

**sail** [seɪ]

*n.* 船帆

**bow** [bo]

*n.* 船首

**wooden** ['wudən]

*adj.* 木制的

## ship

**ship** [ʃɪp]

*n.* 大船; 船舰

**smokestack** ['smok. stæk]

*n.* (船或火车等的) 烟囱



**steam** [sti:m]

*n.* 蒸汽

**deck** [dæk]

*n.* 甲板

**steamer** ['sti:mə]

*n.* 蒸汽船; 轮船

**ferry** ['fəri]

*n.* 渡船

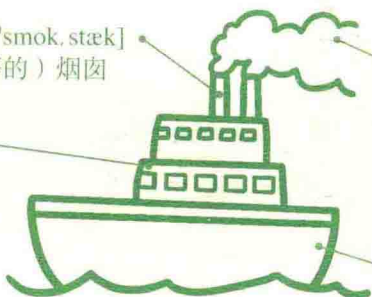

**liner** ['laɪnə]

*n.* 游轮, 客轮

## airplane

wing [wɪŋ]  
n. 机翼; 翅膀

cockpit ['kɒk.pɪt]  
n. 驾驶舱

cloud [klaʊd]  
n. 云

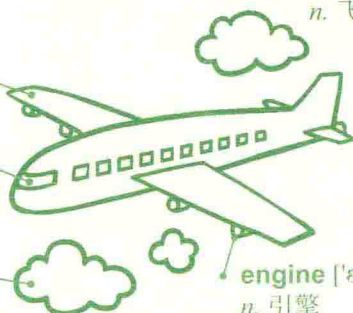

airplane ['eɪ.plen]  
n. 飞机

flight [flaɪt]  
n. 飞行

engine ['ɛndʒɪn]  
n. 引擎

## airport

runway ['rʌn.weɪ]  
n. 机场跑道

hardstand ['hɑ:d.stænd]  
n. (跑道附近的) 停机坪

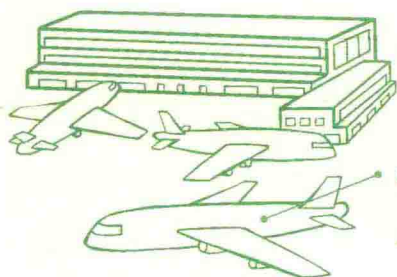

airport ['eɪ.pɔ:rt]  
n. 机场

airplane ['eɪ.plen]  
n. 飞机

## earth

Arctic ['ɑ:ktɪk]  
adj. 北极的

ocean ['oʊʃən]  
n. 海洋

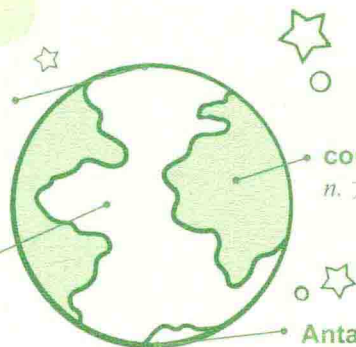

earth [ɜ:θ]  
n. 地球

continent ['kɒntənənt]  
n. 大陆, 洲

Antarctic [æn'tɑ:ktɪk]  
adj. 南极的

# Day 6 衣着、家居与日常用品

- clothes
- T-shirt
- vest
- sweater
- coat
- pants
- jacket
- shirt
- dress
- blouse
- uniform
- evening dress
- tie
- pajamas
- glove
- glasses
- wallet
- comb
- brush
- key
- camera
- medicine
- mug
- bowl
- machine
- bulb
- box
- mat
- desk
- table
- chair
- artwork
- picture
- clock
- stereo
- newspaper
- computer
- bathroom
- bedroom
- apartment
- house
- indoor

## clothes

**bow** [bo]  
n. 蝴蝶结

**towel** ['tauəl]  
n. 毛巾

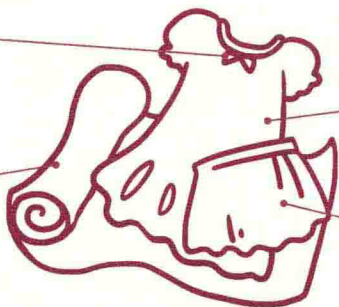

**clothes** [kloz]  
n. 衣服; 服装

**dress** [dres]  
n. 连衣裙

**skirt** [skɜ:t]  
n. 裙子

## T-shirt

**sleeve** [sliv]  
n. 袖子

**logo** ['lago]  
n. 标志

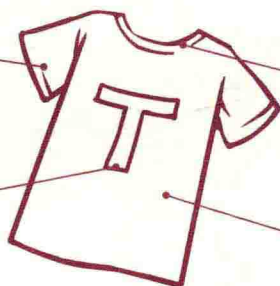

**T-shirt** ['ti:ʃɜ:t]  
n. T恤, 短袖圆领衫

**collar** ['kələ]  
n. 衣领

**fabric** ['fæbrɪk]  
n. 布料

## vest

**tag** [tæg]  
n. 标签



**vest** [vest]  
n. 背心

**collar** ['kələ]  
n. 衣领

**pocket** ['pəukɪt]  
n. 口袋

\* wear 的三种时态是 wear/wore/worn

## sweater

**sweater** ['swetə]

*n.* 毛衣

**turtleneck** ['tɜ:tl,nek]

*n.* 高领衫

**fleece** [fli:s]

*n.* 羊毛; 毛线

**cuff** [kʌf]

*n.* 袖口

**cotton** ['kɒtən]

*n.* 棉花



## coat

**coat** [kɒt]

*n.* 外套; 大衣

**collar** ['kɒlə]

*n.* 衣领

**pocket** ['pɒkɪt]

*n.* 口袋

**cuff** [kʌf]

*n.* 袖口

**fur** [fɜ:]

*n.* 皮毛

**button** ['bʌtən]

*n.* 纽扣

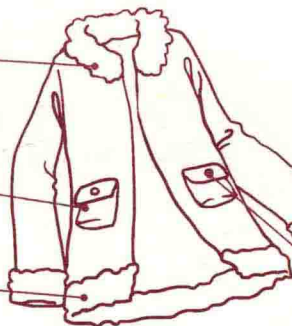

## pants

**pants** [pænts]

*n.* 长裤

**belt** [belt]

*n.* 皮带

**zipper** ['zɪpə]

*n.* 拉链

**zip** [zɪp]

*v.* 拉上拉链

**jeans** [dʒi:nz]

*n.* 牛仔裤

**wear** [weə]

*v.* 穿着

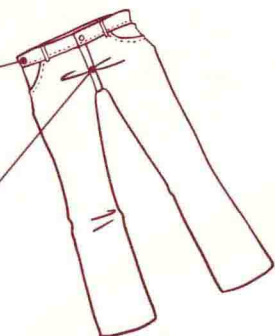



# jacket

**jacket** ['dʒækɪt]

*n.* 夹克

**baseball cap** ['bes, bɒl kæp]

*n.* 棒球帽

**tooth** [tuθ]

*n.* 牙齿

**belly** ['bɛli]

*n.* 腹部, 肚子

**knee** [ni]

*n.* 膝盖

**barefoot** ['bɛr, fut]

*adj.* 赤脚的

**foot** [fut]

*n.* 脚, 足

**coat** [kɒt]

*n.* 外套

**belly button**

['bɛli 'bʌtən]

*n.* 肚脐

**shorts** [ʃɔrts]

*n.* 短裤

**zipper** ['zipə]

*n.* 拉链

**toe** [to]

*n.* 脚趾

\*tooth 的复数形式为 teeth [tiθ]

\*foot 的复数形式为 feet [fi:t]

## shirt

shirt [ʃɜ:t]

n. 衬衫; 男衬衫

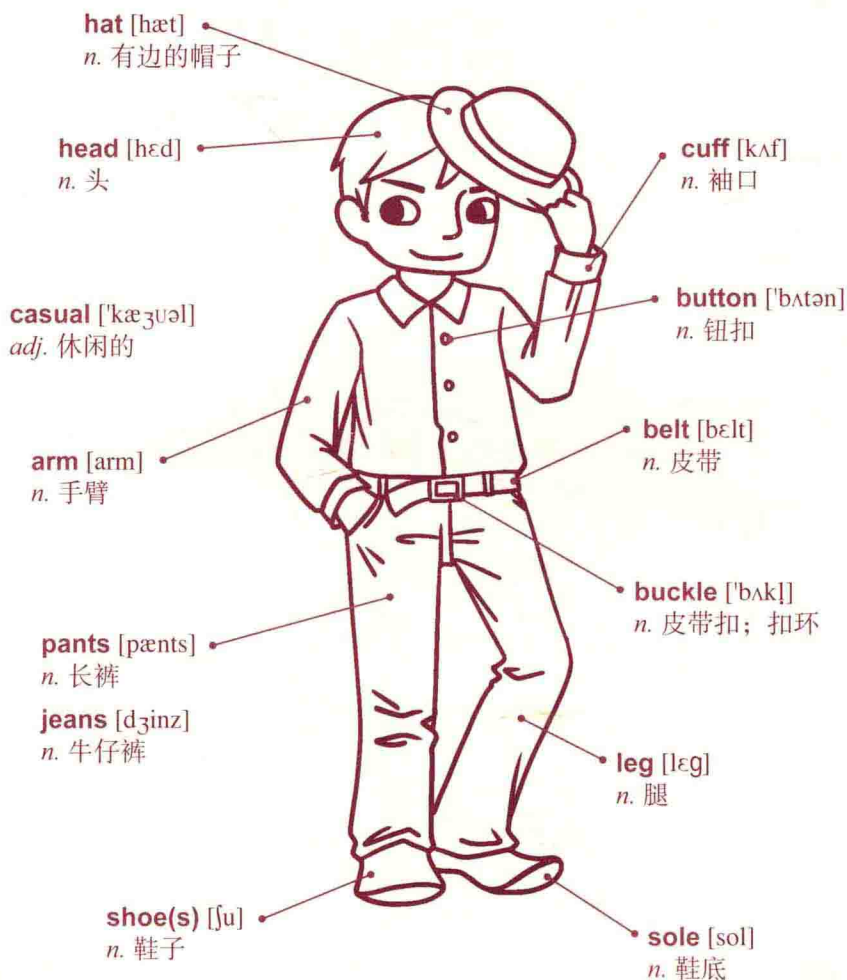

# dress

**dress** [dres]

*n.* 连衣裙

**childhood** ['tʃaɪld.hud]

*n.* 幼年时期

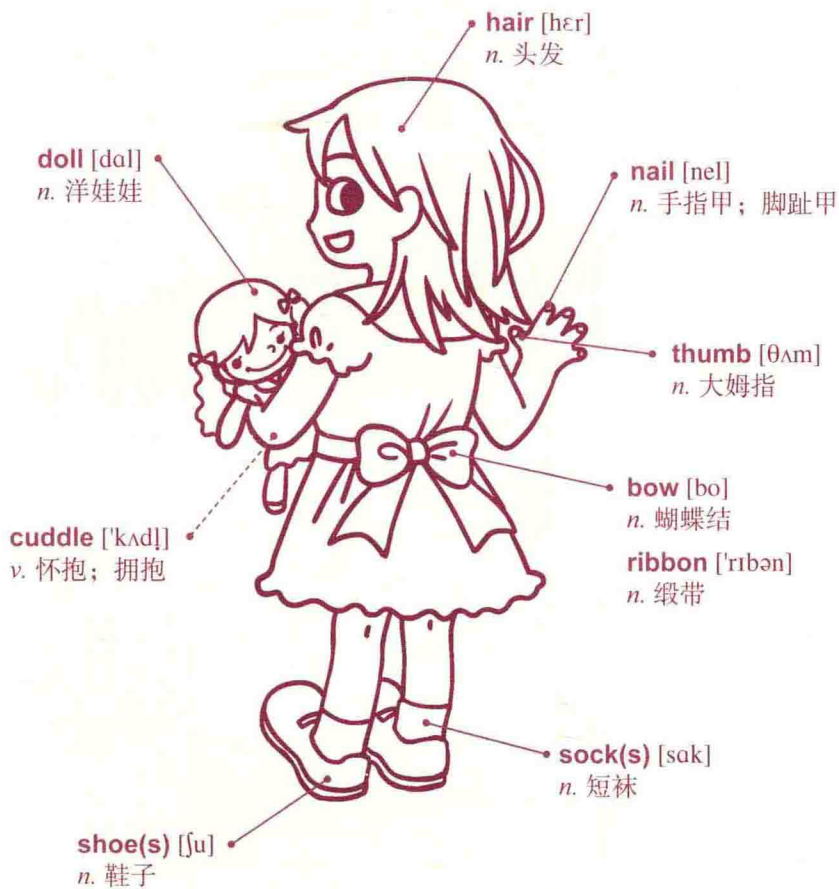

## blouse

**blouse** [blaʊz]  
n. (女性或儿童的) 上衣

**parasol** ['pærə.səl]

n. 遮阳伞

**umbrella** [ʌm'brɛlə]

n. 雨伞

**protect** [prə'tekt]

v. 保护

**neck** [nek]

n. 脖子

**top** [tɒp]

n. 上衣

**purse** [pɜ:s]

n. 钱包; 女用提包

**handbag** ['hænd.bæg]

n. (女用) 手提袋

**handle** ['hændl]

n. 把手

**shoe(s)** [ʃu]

n. 鞋子



## uniform

**brim** [brɪm]  
n. 帽沿; 边缘

**salute** [sə'lut]  
v. 向……行礼

**badge** [bædʒ]  
n. 徽章; 奖章

**on duty** [ən 'dju:ti]  
ph. 值勤; 工作中



**uniform** ['ju:nə, fɔ:m]  
n. 制服

**cap** [kæp]  
n. 制服帽;  
(表示职业等的) 帽子

**duty** ['dju:ti]  
n. 责任

**tie** [taɪ]  
n. 领带

## evening dress

**earring** ['i:rɪŋ]  
n. 耳环

**scarf** [skɑ:f]  
n. 围巾; 披巾



**evening dress** ['i:vniŋ dres]  
n. 晚礼服

**bracelet** ['breslɪt]  
n. 手镯; 臂镯

## tie

**tie** [taɪ]  
v. 系紧

**tighten** ['taɪtən]  
v. 系紧

**sleeve** [sli:v]  
n. 袖子

**necktie** ['nek, taɪ]  
n. 领带; 领结

**shirt** [ʃɜ:t]  
n. 衬衫



**collar** ['kɒlə]  
n. 衣领

**cuff** [kʌf]  
n. 袖口

**wrinkle** ['rɪŋkəl]  
n. 皱褶; 皱纹

**tie** [taɪ]  
n. 领带

## pajamas

**brush** [brʌʃ]  
v. 刷

**toothbrush** ['tuθ, brʌʃ]  
n. 牙刷

**toothpaste** ['tuθ, pest]  
n. 牙膏



**pajamas** [pə'dʒæməs]  
n. 【美】(宽松的) 睡衣裤

**pyjamas** [pə'dʒæməs]  
n. 【英】(宽松的) 睡衣裤

**foam** [fəʊm]  
n. 泡沫

**cup** [kʌp]  
n. 杯子

**bedtime** ['bed, taɪm]  
n. 就寝时间

## glove

**warm** [wɔ:m]  
adj. 暖和的

**waterproof** ['wɔ:tə, pruf]  
adj. 防水的



**glove** [glɒv]  
n. 手套

**finger** ['fɪŋgə]  
n. 手指; 手指的部位

**pattern** ['pætə:n]  
n. 花纹

## glasses

**eyesight** ['ai, saɪt]  
n. 视力

**glasses** ['glæsɪz]  
n. 眼镜

**nose piece** [noz pi:s]  
n. 鼻垫

**arm** [ɑ:m]  
n. 镜架; 手臂

**lens** [lenz]  
n. 镜片

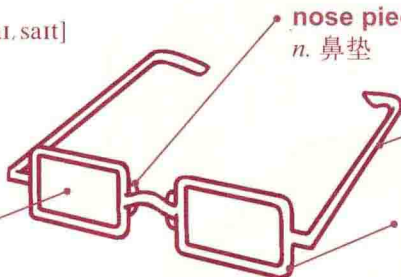

**frame** [frem]  
n. 镜架; 骨架, 结构

## wallet

**pay** [pe]

v. 付款

**payment** ['pemənt]

n. 付款

**picture** ['pɪktʃə]

n. 照片

**bill** [bɪl]

n. 纸币



**wallet** ['wɒlɪt]

n. 钱包; 皮夹

**money** ['mʌni]

n. 钱; 货币

**spend** [spænd]

v. 花费

## comb

**hairdo** ['hɛr, du]

n. 发型

**handle** ['hændl]

n. 柄; 柄状物

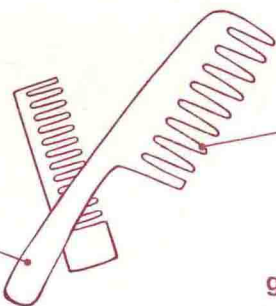

**comb** [kɒm]

n. 梳子

**prong** [prɒŋ]

n. 梳齿

**groom** [grʊm]

v. 梳理打扮

## brush

**toothbrush** ['tuθ, brʌʃ]

n. 牙刷

**handle** ['hændl]

n. 柄; 柄状物

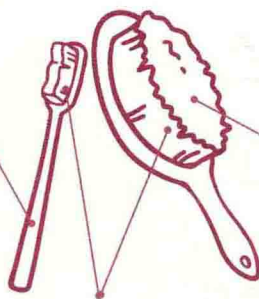

**brush** [brʌʃ]

n. 刷子

v. 刷

**hairbrush** ['hɛr, brʌʃ]

n. 发刷

**bristle(s)** ['brɪs]

n. 刷毛

**comb** [kɒm]

n. 梳子



## key

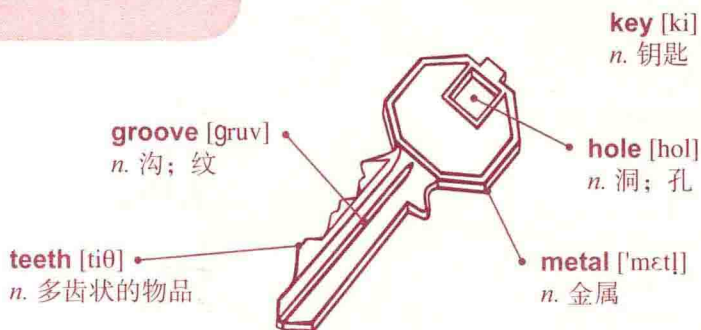

## camera

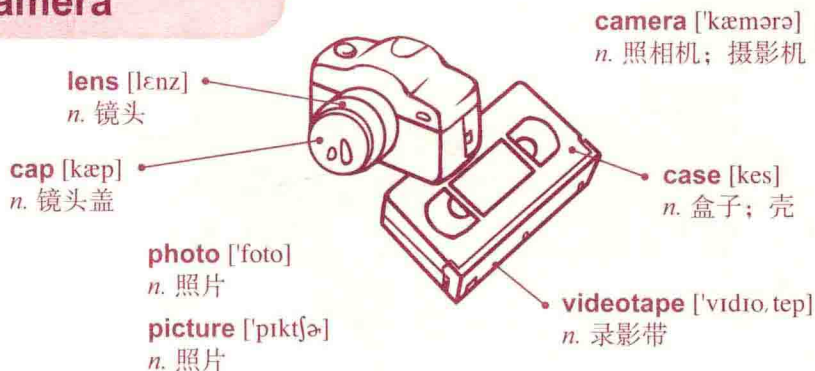

## medicine

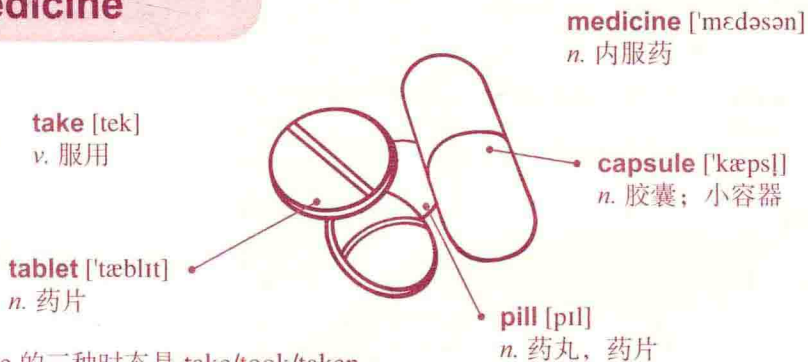

\* take 的三种时态是 take/took/taken

## mug

**porcelain** ['pɔːslɪn]

*n.* 瓷器

**cup** [kʌp]

*n.* 杯子

**drink** [drɪŋk]

*v.* 喝

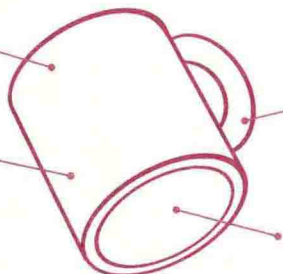

**mug** [mʌɡ]

*n.* 马克杯;  
有柄的大杯子

**handle** ['hændl]

*n.* 握柄, 把手

**bottom** ['bɒtəm]

*n.* 底部

## bowl

**meal** [mi:l]

*n.* 膳食; 餐

**chopstick(s)** ['tʃɒp.stɪk]

*n.* 筷子

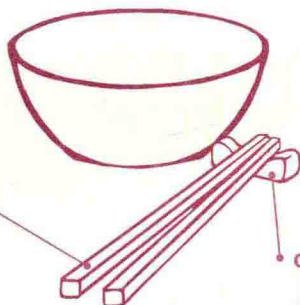

**bowl** [bɒl]

*n.* 碗

**chopsticks holder**

['tʃɒp.stɪks 'hɒldə]

*n.* 筷子架

## machine

**coffee machine** ['kɒfi məʃɪn]

*n.* 咖啡机

(= coffee maker ['kɒfi 'meɪkə])



**machine** [məʃɪn]

*n.* 机器

**filter** ['fɪltə]

*n.* 滤器; 滤纸

**coffee** ['kɒfi]

*n.* 咖啡

## bulb

**shine** [ʃaɪn]  
v. 发亮; 照耀

**turn on** [tɜ:n ɔn]  
ph. 打开 (电源等)

**turn off** [tɜ:n ɔf]  
ph. 关掉 (电源等)



**bulb** [bʌlb]  
n. 灯泡

**cord** [kɔ:d]  
n. 电线

**light bulb** [laɪt bʌlb]  
n. 灯泡

**light** [laɪt]  
n. 光线; 光亮

## box

**document** ['dɒkjəmənt]  
n. 文件

**paper** ['peɪpə]  
n. 纸

**contain** [kən'teɪn]  
v. 包含; 收纳

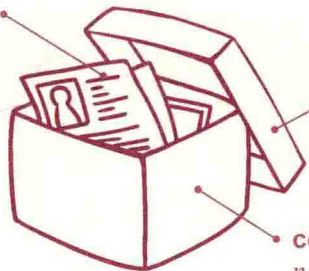

**box** [bɒks]  
n. 箱子; 盒子

**top** [tɒp]  
n. 顶部

**container** [kən'teɪnə]  
n. 容器

## mat

**mat** [mæt]  
n. 踩脚垫; 地垫

**edge** [ɛdʒ]  
n. 边缘

**carpet** ['kɑ:pɪt]  
n. 地毯

**pattern** ['pætə:n]  
n. 花纹

**rug** [rʌg]  
n. 小地毯

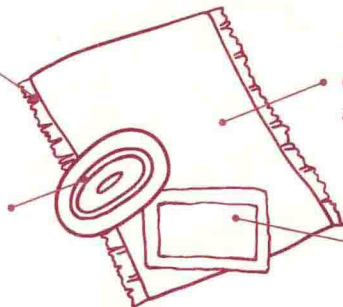

## desk

**leg** [lɛg]

*n.* 腿, 足; 小腿

**open** ['oʊən]

*v.* 打开

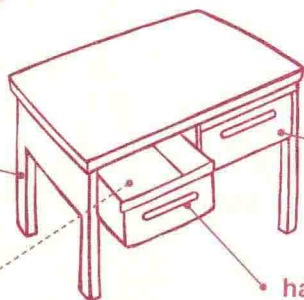

**desk** [dɛsk]

*n.* 书桌; 办公桌

**drawer** ['drɔə]

*n.* 抽屉

**handle** ['hændl]

*n.* 握把

## table

**surface** ['sɜːfɪs]

*n.* 表面

**leg** [lɛg]

*n.* 桌脚

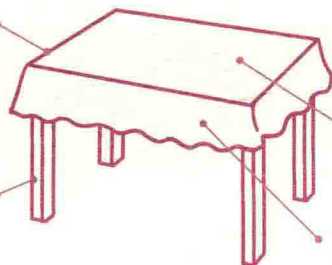

**table** ['teɪb]

*n.* 餐桌; 桌子

**tabletop** ['teɪb, tɒp]

*n.* 桌面

**tablecloth** ['teɪb, klɒθ]

*n.* 桌布

## chair

**back** [bæk]

*n.* 椅背

**seat** [sit]

*n.* 椅面

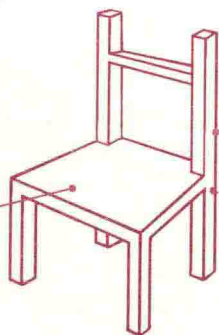

**chair** [tʃɛr]

*n.* 椅子

**wood** [wud]

*n.* 木材

**wooden** ['wudən]

*adj.* 木制的

## artwork

statue ['stætʃu]

n. 雕像

sculpture ['skʌlptʃə]

n. 雕塑品; 雕像

creative [kri'eɪtɪv]

adj. 有创造力的

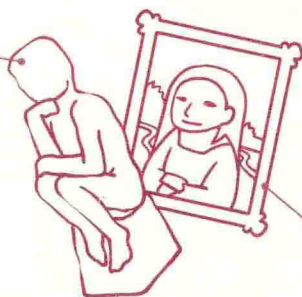

artwork ['ɑ:twɜ:k]

n. 艺术品; 美术品

art [ɑ:t]

n. 艺术; 美术

frame [frem]

n. 画框; 骨架

## picture

border ['bɔ:də]

n. 边缘; 饰边

picture ['pɪktʃə]

n. 图片; 相片

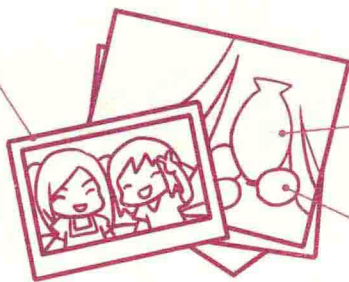

vase [ves]

n. 花瓶

fruit [fru:t]

n. 水果

## clock

hand [hænd]

n. 指针

clock [klɒk]

n. 时钟

round [raʊnd]

adj. 圆形的

time [taɪm]

n. 时间

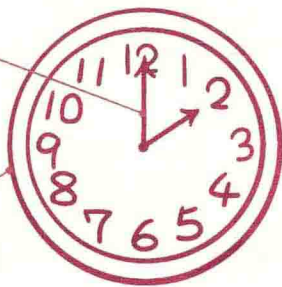

hour [aʊə]

n. 小时

## stereo

**antenna** [æn'tenə]  
n. 天线

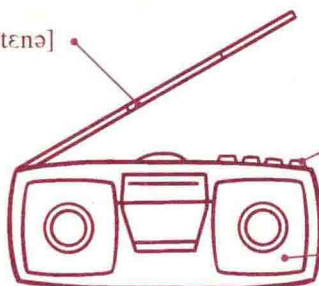

**stereo** ['steriə]  
n. 立体声音响

**button** ['bʌtən]  
n. 按钮

**speaker** ['spi:kə]  
n. 喇叭

## newspaper

**anchor** ['æŋkə]  
n. 主播

**news anchor** [nju:z 'æŋkə]  
n. 电视新闻主播

**TV** ['ti:vi]  
n. 电视机  
\* 为 television ['telə.vɪʒən] 的缩写



**newspaper** ['nju:z. pepə]  
n. 报纸

**watch** [wɒtʃ]  
v. 观看

**read** [ri:d]  
v. 阅读; 朗读

**article** ['ɑ:tɪkl]  
n. 文章

## computer

**screen** [skrin]  
n. 屏幕

**monitor** ['mɒnətə]  
n. 显示器

**keyboard** ['ki:bɔ:d]  
n. 键盘

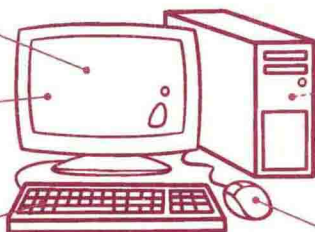

**computer** [kəm'pjutə]  
n. 电脑

**hard drive**  
[hɑ:d draɪv]  
n. 硬盘

**mouse** [maʊs]  
n. 鼠标

## bathroom

bathroom ['bæθ, rum]

n. 浴室

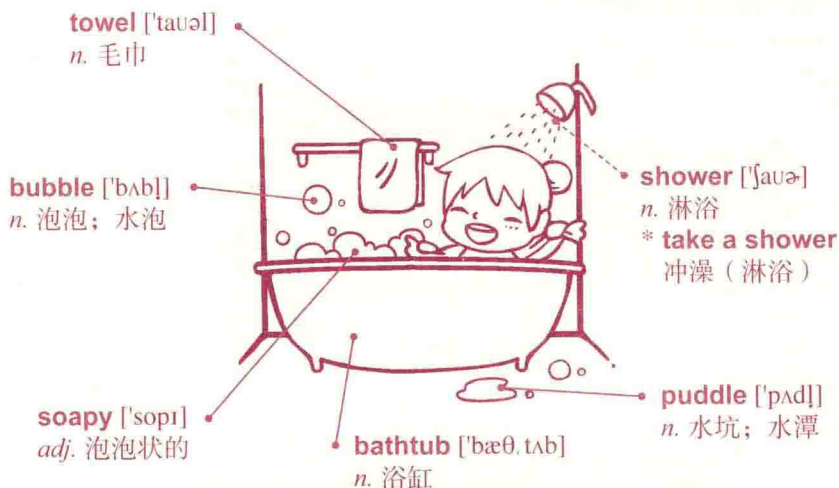

## bedroom

bedroom ['bed, rum]

n. 卧室

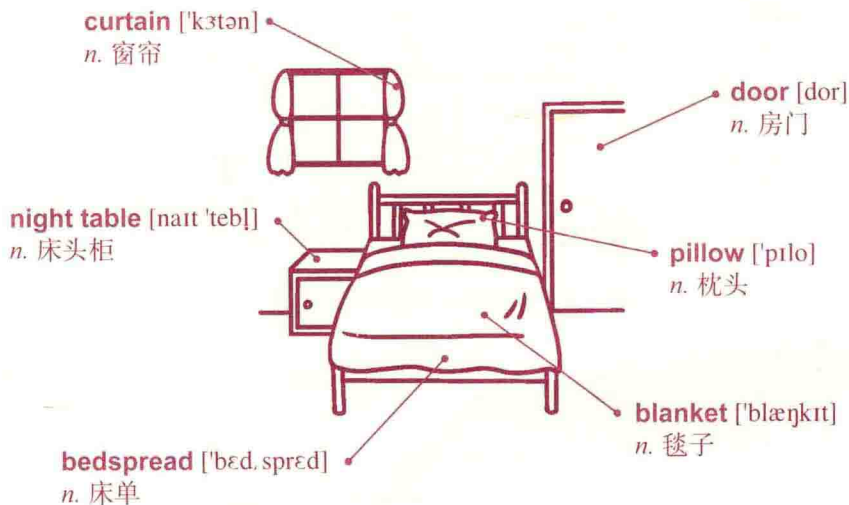



## apartment

**apartment** [ə'pɑ:tmənt]  
n. 公寓住宅

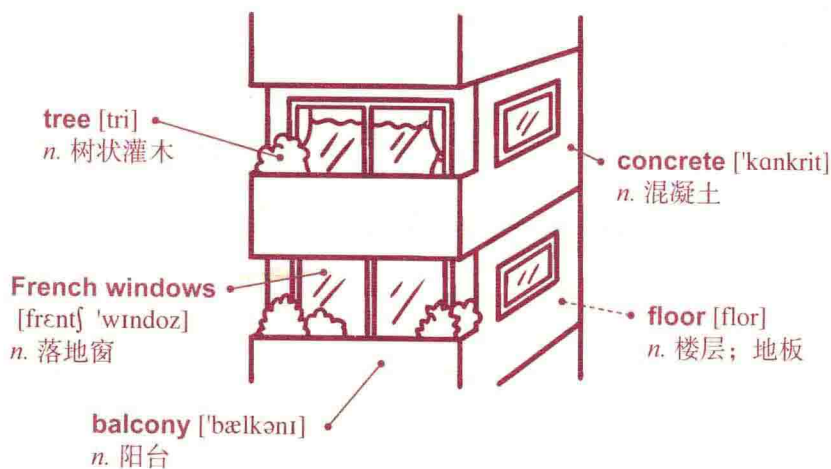

## house

**house** [haus]  
n. 房子

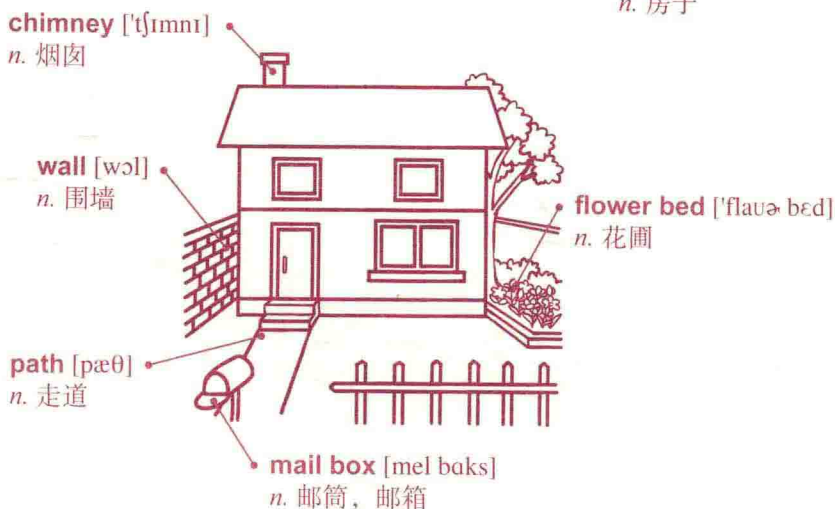

# indoor

**indoor** ['ɪn.dɔːr]

adj. 室内的

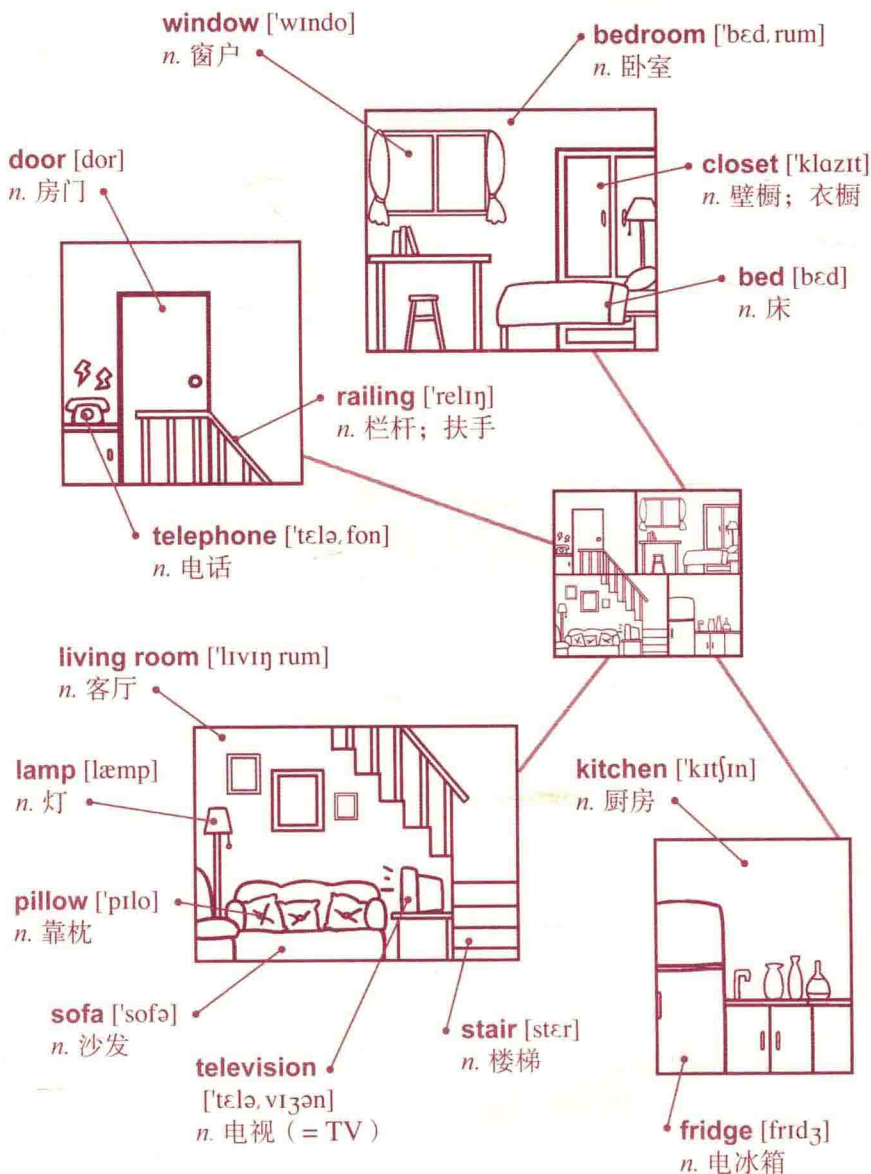

# Day 7 天气、时间、 介词与双关语

- cloud
- rain
- rainbow
- wind
- snow
- crescent
- universe
- typhoon
- drought
- spring
- summer
- autumn
- winter
- morning
- afternoon
- evening
- night
- Easter
- Halloween
- Thanksgiving
- Christmas
- quarter
- hour
- calendar
- under
- beside
- behind
- between
- inside
- ahead
- along
- oil
- close
- gas
- die
- mouse & rat
- bear
- notebook
- chicken
- bat

## cloud

**white** [hwaɪt]  
adj. 白色的

**fluffy** ['flʌfɪ]  
adj. 蓬松的; 松软的

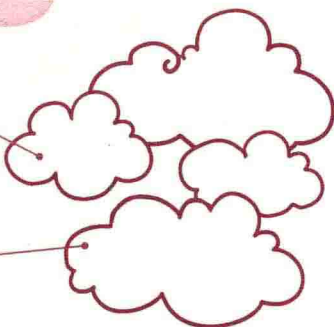

**cloud** [klaʊd]  
n. 云

**cloudy** ['klaʊdɪ]  
adj. 多云的, 阴天的

## rain

**wet** [wɛt]  
adj. 潮湿的

**umbrella** [ʌm'brɛlə]  
n. 雨伞

**precipitation** [prɪˌsɪpɪ'teɪʃən]  
n. 降雨; 降雪



**rain** [reɪn]  
n. 雨, 雨水

**drop** [drɒp]  
n. 水滴

**rainy** ['reɪnɪ]  
adj. 下雨的

**rainfall** ['reɪn.fɔ:l]  
n. 降雨; 降雨量

## rainbow

**blue** [blu]  
adj. 蓝色的

**indigo** ['ɪn.dɪɡo]  
adj. 靛蓝色的

**violet** ['vaɪələɪt]  
adj. 紫色的

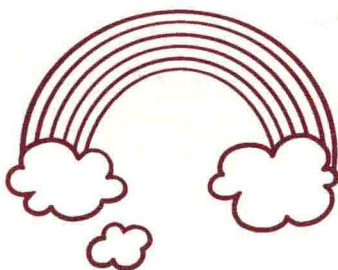

**rainbow** ['reɪn.bo]  
n. 彩虹

**red** [rɛd]  
adj. 红色的

**orange** ['ɒrɪndʒ]  
adj. 橙色的

**yellow** ['jeləʊ]  
adj. 黄色的

**green** [ɡriːn]  
adj. 绿色的

## wind

**holiday** ['hɒlə.dei]  
n. 节日; 休假日

**wind** [waɪnd]  
n. 风  
**windy** ['waɪndi]  
adj. 起风的; 有风的

**trip** [trɪp]  
n. 旅行; 行程

**tourist** ['tʊərɪst]  
n. 游客

**travel** ['trævl]  
v. 旅行  
n. 旅途



**suitcase** ['su:t.keɪs]  
n. 旅行箱; 登机箱

**vacation** [ve'keɪʃən]  
n. 休假

**luggage** ['lʌɡɪdʒ]  
n. 行李

## snow

**snowy** ['snoʊ]  
adj. 下雪的

**snow** [snoʊ]  
n. 雪

**branch** [bræntʃ]  
n. 树枝

**pail** [peɪl]  
n. 桶

**snowflake** ['snoʊ.fleɪk]  
n. 雪花

**carrot** ['kærət]  
n. 胡萝卜

**cold** [kɒld]  
adj. 寒冷的

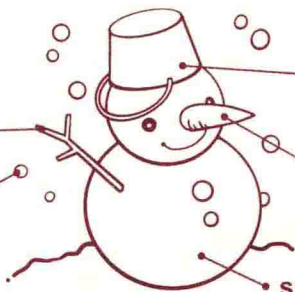

**snowman** ['snoʊ.mæn]  
n. 雪人

## crescent

**moon** [mun]

*n.* 月亮

**bright** [braɪt]

*adj.* 发亮的

**cloud** [klaʊd]

*n.* 云

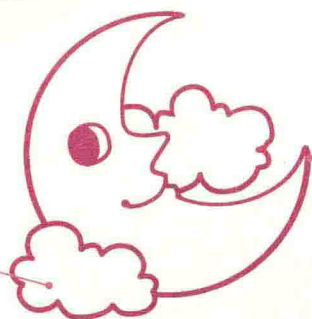

**crescent** ['krɛsnt]

*n.* 弦月

**point** [pɔɪnt]

*n.* 尖端

**sky** [skaɪ]

*n.* 天空

**crescent-shaped**

['krɛsntʃeɪpt]

*adj.* 月牙状的

## universe

**planet** ['plænit]

*n.* 行星

**ring** [rɪŋ]

*n.* 圈; 环状物

**asteroid** ['æstə.rɔɪd]

*n.* 小行星

**space** [speɪs]

*n.* 太空

**universe** ['ju:nə.vɜ:s]

*n.* 宇宙

**comet** ['kəmit]

*n.* 彗星

**star** [stɑ:]

*n.* 恒星

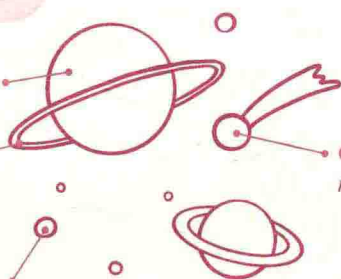

## typhoon

**mainland** ['menlənd]

*n.* 本土, 大陆

**island** ['aɪlənd]

*n.* 岛

**strait** [streɪt]

*n.* 海峡

**clockwise** ['klɒk.waɪz]

*adj.* 顺时针方向的;  
右旋的

**route** [ru:t]

*n.* 路径

**path** [pæθ]

*n.* 路线

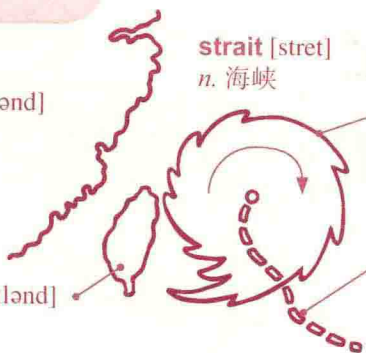



## drought

**scorched** [skɔ:tʃt]  
adj. 干枯的

**cracked** [krækt]  
adj. 龟裂的

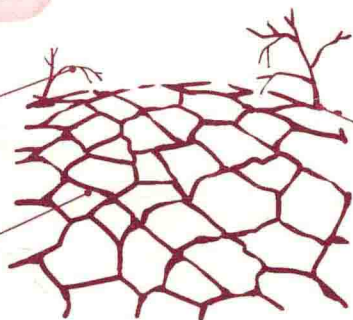

**drought** [draʊt]  
n. 干旱

**dead** [dæd]  
adj. 死的; 干枯的

**dry** [draɪ]  
adj. 干燥的

## spring

**weed** [wi:d]  
n. 野草

**rock** [rɒk]  
n. 石块

**bush** [bʊʃ]  
n. 灌木丛

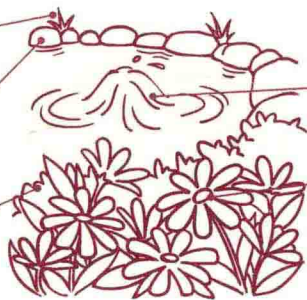

**spring** [sprɪŋ]  
n. 春季

**spring** [sprɪŋ]  
n. 泉水

**daisy** ['deɪzi]  
n. 雏菊

**season** ['si:zn]  
n. 季节

## summer

**hot** [hɒt]  
adj. 炎热的

**humid** ['hju:mɪd]  
adj. 潮湿的

**sunny** ['sʌni]  
adj. 阳光充足的

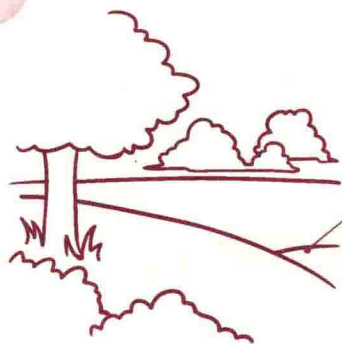

**summer** ['sʌmə]  
n. 夏季

**field** [fi:ld]  
n. 原野

**season** ['si:zn]  
n. 季节



## autumn



## winter



## morning

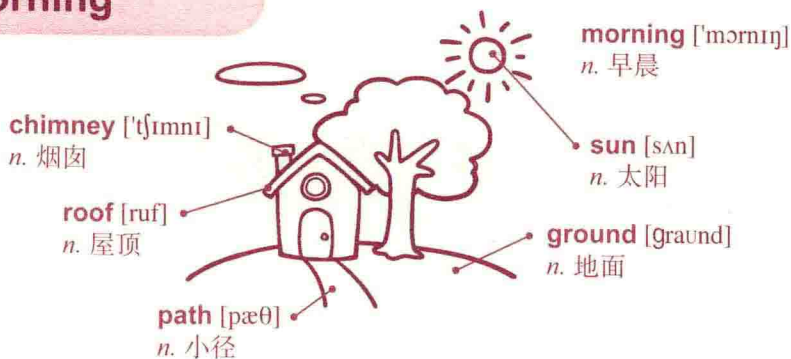

## afternoon

**afternoon** [ˌæftəˈnuːn]

*n.* 下午, 午后

**shine** [ʃaɪn]

*v.* 照耀

**cloud** [klaʊd]

*n.* 云

**shadow** [ˈʃædəʊ]

*n.* 阴影



**noon** [nuːn]

*n.* 正午, 中午

**tree** [triː]

*n.* 树; 乔木

## evening

**evening** [ˈiːvɪŋɪŋ]

*n.* 傍晚; 晚上

**bird** [bɜːd]

*n.* 鸟

**sun** [sʌn]

*n.* 太阳



**sunset** [ˈsʌn. set]

*n.* 日落

## night

**night** [naɪt]

*n.* 夜晚

**moon** [muːn]

*n.* 月亮

**star** [stɑː]

*n.* 星星



**dark** [dɑːk]

*adj.* 黑暗的

## Easter

**ear** [ɪr]  
*n.* 耳朵

**hop** [hɒp]  
*v.* 蹦跳

**Easter egg** ['ɪstə ɛg]  
*n.* 复活节彩蛋

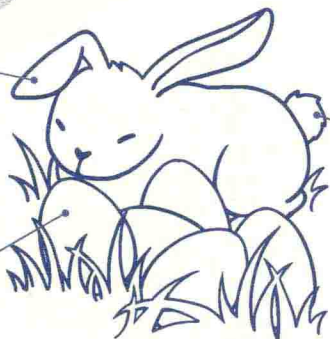

**Easter** ['ɪstə]  
*n.* 复活节

**tail** [teɪl]  
*n.* 尾巴

**cute** [kjut]  
*adj.* 可爱的

## Halloween

**Jack-o'-lantern** ['dʒækə, læntən]  
*n.* 南瓜灯

**skull** [skʌl]  
*n.* 骷髅头

\* **trick or treat** [trɪk ɔr trit]  
不给糖就捣蛋



**Halloween** [ˌhæloʊɪn]  
*n.* 万圣节

**pumpkin** ['pʌmpkɪn]  
*n.* 南瓜

**cape** [keɪp]  
*n.* 斗篷

## Thanksgiving

**Thanksgiving** [ˌθæŋks'ɡrɪvɪŋ]

*n.* 感恩节

**turkey** ['tɜːki]

*n.* 火鸡

**stuffing** ['stʌfɪŋ]

*n.* 填料

**dish** [dɪʃ]

*n.* 碟, 盘; 菜肴

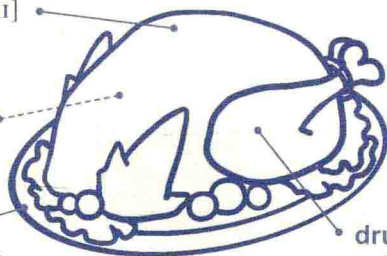

**roast** [rɔːst]

*adj.* 烤的

**drumstick** ['drʌm.stɪk]

*n.* (煮熟的) 鸡腿

## Christmas

**Christmas** ['krɪsməs]

*n.* 圣诞节 (= Xmas)

**decoration** [ˌdeɪkə'reɪʃən]

*n.* 饰品

**celebration** [ˌsɛlə'breɪʃən]

*n.* 庆祝

**star** [stɑː]

*n.* 星形物

**ribbon** ['rɪbən]

*n.* 缎带

**pot** [pɒt]

*n.* 盆

**present** ['preznt]

*n.* 礼物

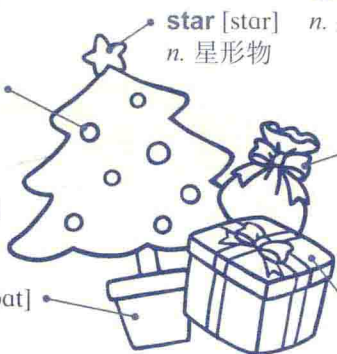

## Chinese Festivals

**Chinese New Year** 农历新年

**Lantern Festival** 元宵节

**Dragon Boat Festival** 端午节

**Mid-Autumn Festival** 中秋节

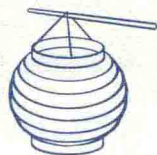

## quarter

**divide** [dɪ'vaɪd]  
v. 划分

**piece** [pi:s]  
n. 一片

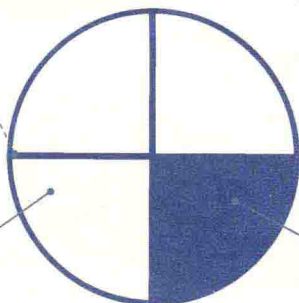

**quarter** ['kwɔ:tə]

n. 四分之一  
(= 一季  
= 一刻钟, 十五分钟  
= 二十五美分)

**sector** ['sektə]  
n. 【数】扇形

## hour

**minute hand**  
['mɪnɪt hænd]  
n. 分针

**second** ['sekənd]  
n. 秒

**clock** [klɒk]  
n. 时钟

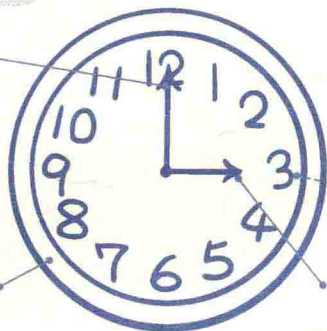

**hour** [aʊr]  
n. 小时

**minute** ['mɪnɪt]  
n. 分钟

**o'clock** [ə'klɒk]  
adv. ……点钟

**hour hand** [aʊr hænd]  
n. 时针

## 时间介词

**at 2 o'clock** 在两点钟 (的时候)

**on 31, July** 在七月三十一日 (那一天)

**on Sunday** 在星期日 (那一天)

**in the afternoon** 在下午 (的时候)



## calendar

**weekend** ['wik.ɛnd]  
n. 周末

**weekday** ['wik.de]  
n. 工作日 (指周一到周五)

**January** ['dʒænju.ɛrɪ]  
n. 一月

**February** ['febru.ɛrɪ]  
n. 二月

**March** [mɑ:tʃ]  
n. 三月

**April** ['eprəl]  
n. 四月

**May** [meɪ]  
n. 五月

**June** [dʒun]  
n. 六月

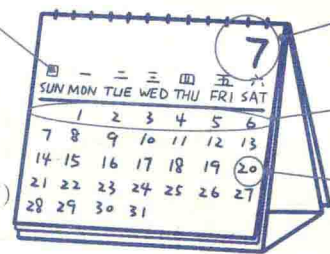

**calendar** ['kælɪndə]  
n. 日历; 历书

**month** [mʌnθ]  
n. 月

**week** [wik]  
n. 一星期

**day** [deɪ]  
n. 一天

**July** [dʒu'laɪ]  
n. 七月

**August** [ɔ'gʌst]  
n. 八月

**September** [sɛp'tembə]  
n. 九月

**October** [ɒk'təbə]  
n. 十月

**November** [nə'vembə]  
n. 十一月

**December** [di'sembə]  
n. 十二月

**Sunday** ['sʌndeɪ]  
n. 星期日

**Monday** ['mʌndeɪ]  
n. 星期一

**Tuesday** ['tju:zdeɪ]  
n. 星期二

**Wednesday** ['wenzdeɪ]  
n. 星期三

**Thursday** ['θɜ:zdeɪ]  
n. 星期四

**Friday** ['fraɪdeɪ]  
n. 星期五

**Saturday** ['sætədeɪ]  
n. 星期六

**in July** 在七月 (的时候)

**in winter** 在冬天 (的时候)



\* **at** 用在“时刻、时间的一个点”  
**on** 用在“日期或星期 (的某一天)”  
**in** 用在“月份、季节、年或世纪”



## under

**under** ['ʌndə]  
*prep.* 在……下方

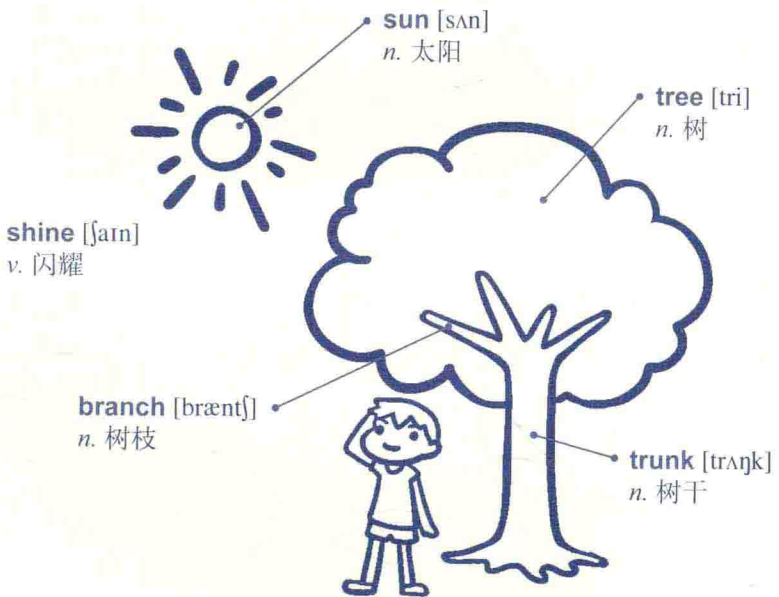
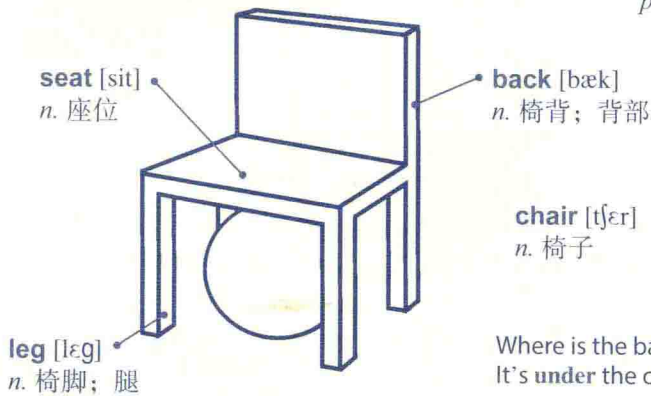

The sun is shining so brightly. 太阳好晒喔。  
Let's stand **under** the tree. 我们去树（荫）底下吧。



## beside

**brother** ['brʌðə]

*n.* 兄弟

**older** [oldə]

*adj.* 年长的

**love** [lʌv]

*v.* 爱

*n.* 疼爱



**beside** [br'saɪd]

*prep.* 在……旁边

**younger** ['jʌŋgə]

*adj.* 比较年轻的

**shorter** [ʃɔ:tə]

*adj.* 比较矮的

**sister** ['sɪstə]

*n.* 姐妹

Is that your sister beside you?

站在你旁边那个是你妹妹吗?

Yes. She is younger and shorter than me.

是啊! 她年纪比我小, 个子也比我矮一点。

## behind

**shocked** [ʃʌkt]

*adj.* 吓一跳的



**behind** [br'hɑ:nd]

*prep.* 在……的后面

**surprise** [sə'praɪz]

*v.* 诧异

**surprised** [sə'praɪzd]

*adj.* 惊奇的

**hide** [haɪd]

*v.* 躲起来, 把……藏起来

Where is Jodie? 乔迪跑到哪里去了?

She is hiding behind you. 她躲在你背后。

Oh, what a surprise! 哇! 吓我一跳。

## between

**encyclopedia** [ɪn.sə'klə'pɪdɪə]

*n.* 百科全书

**between** [brɪ'twɪn]

*prep.* 在……之间

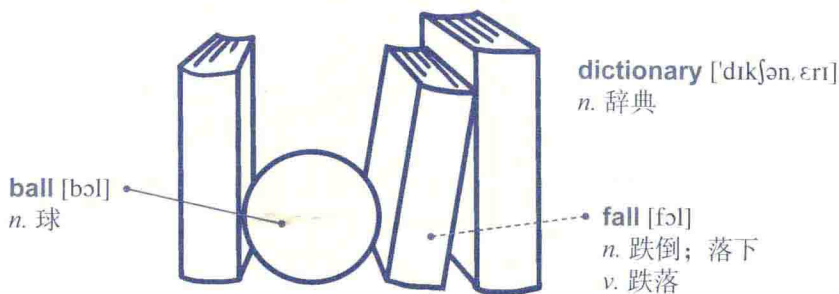

Why did you put the ball **between** the books? 你干嘛把球放在书中间?  
So the books don't fall. 这样书才不会倒下来啊。

## inside

**cardboard** ['kɑ:d.bɔ:d]

*n.* 硬纸板

**box** [bɒks]

*n.* 箱子

**collar** ['kɒlə]

*n.* 项圈

**inside** [ɪn'saɪd]

*prep.* 在里面

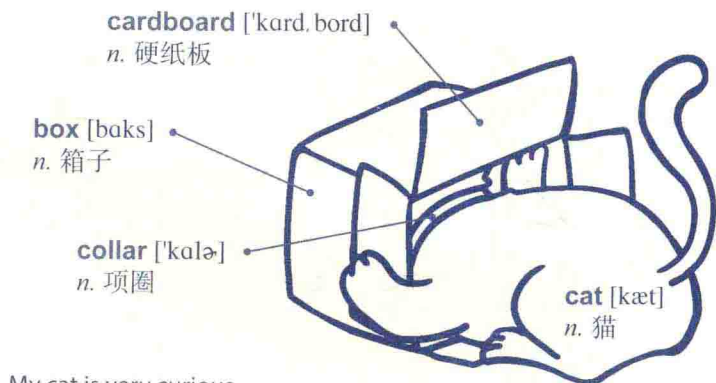

My cat is very curious.

我养的猫总是很好奇。

Yes. His head is **inside** a box.

对啊，它现在（好奇地）把头塞进箱子里去了。

**curious** ['kjʊrɪəs]

*adj.* 好奇的

## ahead

**ahead** [ə'hɛd]  
*prep.* 在……之前的

**in front** [ɪn frʌnt]  
*prep.* 在……之前

**run** [rʌn]  
*v.* 跑

**race** [res]  
*n.* 赛跑



**sweat** [swɛt]  
*v.* 流汗  
*n.* 汗水

**behind** [br'hænd]  
*prep.* 在……的背后

Hurry up! I'm ahead of you. 快点! 我跑得比你快了。  
 You run so fast! 你跑得好快!

## along

**along** [ə'lɔŋ]  
*prep.* 沿着

**walk** [wɔ:k]  
*v.* 走

**step** [stɛp]  
*v.* 跨(步)

**touch** [tʌtʃ]  
*v.* 触摸

**weed** [wi:d]  
*n.* 杂草



Let's walk along this path. 我们沿着这条小路走吧。  
 Sure. Good idea. 嗯, 好主意!

## oil

**oil** [ɔɪl]  
*n.* 石油; 食用油

**opening** [ˈoʊpənɪŋ]  
*n.* 孔, 穴

**barrel** [ˈbærəl]  
*n.* 大桶

**crude oil** [krud ɔɪl]  
*n.* 原油,  
未经提炼的石油

**pour** [pɔː]  
*v.* 倒

**label** [ˈleɪbəl]  
*n.* 商标

**sunflower oil** [ˈsʌn. flauə ɔɪl]  
*n.* 葵花油

\* **olive oil** [ˈɒlɪv ɔɪl]  
*n.* 橄榄油

**vegetable oil** [ˈvedʒətəbəl ɔɪl]  
*n.* 植物油

**drip** [drɪp]  
*v.* 滴下

Oh, no! You made a big mistake.  
不会吧! 你搞错了。  
What?  
啊?  
You bought **oil** for the car, not for cooking!  
你买的“油”是给车用的, 不是煮菜用的。

## close

**close** [kloʊz]  
*v.* 关闭; 打烊  
*adj.* 靠近的

**couple** [ˈkʌpəl]  
*n.* 情侣

**closed** [kloʊzd]  
*adj.* 关闭的

**hug** [hʌg]  
*v.* 拥抱

**glass door** [glæs dɔːr]  
*n.* 玻璃门

**sign** [saɪn]  
*n.* 牌子

Oops. It's too late. The store is **closed**. 喔, 太晚了, 这家店已经打烊了。  
Let's come back tomorrow. 我们明天再来吧。

## gas

**gas** [gæs]  
n. 燃气, 气体

**gasoline** ['gæsə.lɪn]  
n. 汽油 (= gasolene  
= gas [口])

**spill** [spɪl]  
v. 溢出

**gas can** [gæs kæn]  
n. 汽油桶

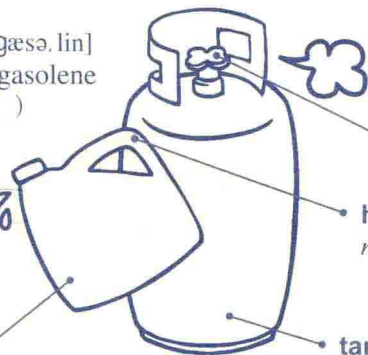

**tap** [tæp]  
n. 阀

**handle** ['hændl]  
n. 把手, 握把

**tank** [tæŋk]  
n. 燃气桶; (贮存水  
或油气等的) 罐、槽

Be careful of the gas! 留意那边有燃气。  
It's OK. I turned the tap off. 放心, 我已经把(燃气)阀关上了。

## die

**rose** [roz]  
n. 玫瑰花; 蔷薇花

**die** [daɪ]  
v. 凋谢; 死亡  
\* die的三种时态为  
die/died/died

**petal** ['petl]  
n. 花瓣

**fall** [fɔ:l]  
v. 掉落

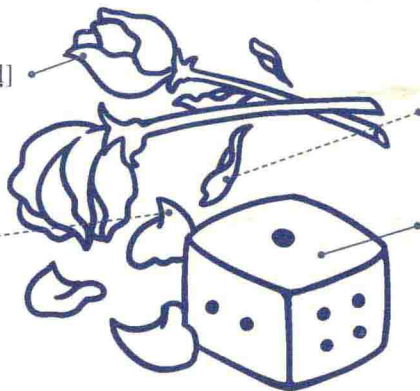

**wilt** [wɪlt]  
v. 枯萎, 凋谢

**die** [daɪ]  
n. 骰子  
\* 常用复数形式  
dice [daɪs]

Do you want to play a dice game? 要不要来玩掷骰子?  
We don't even have one die. 我们连骰子都没有怎么玩?

## mouse & rat

**computer** [kəm'pjutə]  
n. 电脑

**click** [klɪk]  
v. 单击鼠标右键  
n. 卡嗒声

**double-click** ['dʌb] klɪk]  
v. 双击鼠标右键

**whisker** ['hwɪskə]  
n. (动物的) 须

**tooth** [tuθ]  
n. 牙齿  
\* 复数形为 teeth [tiθ]

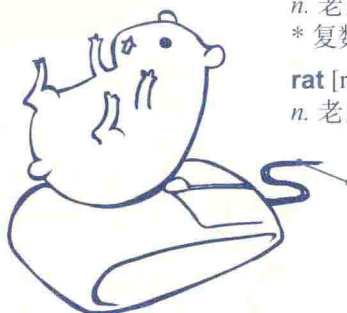

**cable** ['keɪbəl]  
n. 缆线

**cord** [kɔːrd]  
n. 粗线

**fur** [fɜː]  
n. (兽类的) 皮毛

**tail** [teɪl]  
n. 尾巴

**claw** [klɔː]  
n. (动物的) 脚爪

I saw a mouse on your desk. 我看到你桌上有只老鼠。

Eek! Was it big? 啊! 很大吗?

I mean the mouse for your computer. 我说的是你电脑的鼠标。

## bear

**sore** [sɔːr]  
adj. 疼痛的

**pain** [peɪn]  
n. 痛苦

**cry** [kraɪ]  
v. 哭



**bear** [ber]  
n. 熊  
v. 忍受

**Band-Aid** ['bænd.ed]  
n. 创可贴

**tear** [tɪr]  
n. 泪珠

Oh, no! That poor bear hurt his head. 噢……那只可怜的熊熊撞到头了。

He's crying, too. He's so sad. 它在哭, 好可怜呀。

I can't bear you two anymore. 我实在很受不了你们两个!



## notebook

That is an expensive notebook.  
那是很贵的笔记本电脑。  
Yes. I only have a paper notebook.  
是啊。我只买得起纸的笔记本。

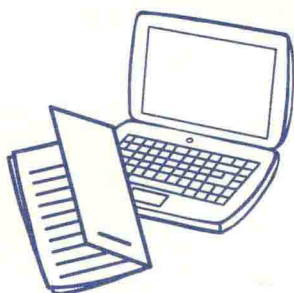

**notebook** ['not. bu:k]  
n. 笔记本; 笔记本电脑

## chicken

**beak** [bi:k]  
n. 喙

**hen** [hen]  
n. 母鸡

**mother** ['mʌðə]  
n. 母亲

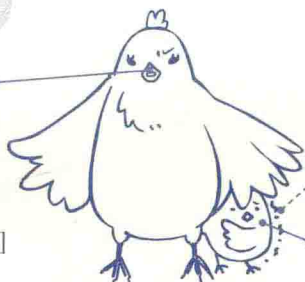

**chicken** ['tʃɪkɪn]  
n. 鸡; 鸡肉  
n. 【俚】胆小鬼  
adj. 【俚】胆小的

**shake** [ʃeɪk]  
v. 颤抖

**chick** [tʃɪk]  
n. 小鸡

You **chicken**! Don't hide behind your mother. 你这个胆小鬼! 别躲在你妈背后!  
He is a **chicken**. 它是只鸡没错啊。

## bat

**creature** ['kri:tʃə]  
n. 生物; 动物

**animal** ['ænəml]  
n. 动物

**scary** ['skəri]  
adj. 吓人的

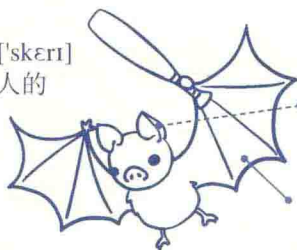

**bat** [bæt]  
n. 蝙蝠; 棒球棒

**sonar** ['sonɑ:  
n. 声纳

**wing** [wɪŋ]  
n. 翅膀

Are you afraid of **bats**? 你会怕蝙蝠（也有棒球棒的意思）吗？  
No, I love baseball! 不会啊，我很爱棒球的。  
Ha, ha. 不好笑。



# Day 8 形容词

- slim
- fat
- tall
- handicapped
- married
- middle-aged
- sore
- sick
- pale
- tired
- unhappy
- careless
- sad
- scared
- scary
- fierce
- humorous
- nervous
- busy
- bored
- confused
- shy
- traditional
- formal
- plenty
- selfish
- strong
- sharp
- pointy
- dangerous
- sticky
- wet
- long
- straight
- recyclable
- expensive
- bright
- clear
- transparent
- smoky
- smelly
- juicy
- sour
- tender
- hidden
- open
- broken
- thin
- thick
- portable

## slim

**sporty** ['spɔ:ti]  
*adj.* 运动的

**young** [jʌŋ]  
*adj.* 年轻的

**teenager** ['ti:n, edʒə]  
*n.* 十几岁的青少年



**ponytail** ['pɒni, tel]  
*n.* 马尾

**shorts** [ʃɔ:ts]  
*n.* 短裤

**slim** [slɪm]  
*adj.* 苗条的

## fat

**suspender(s)** [sə'spɛndə]  
*n.* (裤子的) 吊带

**tall** [tɔ:l]  
*adj.* 高的

**chubby** ['tʃʌbi]  
*adj.* 肥胖的; 丰满的



**short** [ʃɔ:t]  
*adj.* 矮小的; 短的

**little** ['lɪtli]  
*adj.* 小的; 小巧的

**small** [smɔ:l]  
*adj.* 小的; 小型的

**fat** [fæt]  
*adj.* 肥胖的

## tall

**taller** [tɔ:lə]  
*adj.* 比较高的

**shorts** [ʃɔ:ts]  
*n.* 短裤

**boy** [bɔɪ]  
*n.* 少年; 男孩



**tall** [tɔ:l]  
*adj.* 身材高的

**height** [haɪt]  
*n.* 高度

**sock(s)** [sɔ:k]  
*n.* 短袜

## handicapped

**blind** [blaɪnd]  
n. 百叶窗; 窗帘

**disabled** [dɪs'ebld]  
adj. 残障的

**sightless** ['saɪtlɪs]  
adj. 看不见的

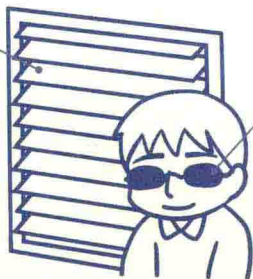

**handicapped** ['hændɪ.kæpt]  
adj. 残障的

**sunglasses** ['sʌn.glæsɪz]  
n. 墨镜

**blind** [blaɪnd]  
adj. 失明的

## married

**wife** [waɪf]  
n. 已婚妇女; 妻子

**female** ['fi:meɪl]  
adj. 女的

**ring** [rɪŋ]  
n. 戒指; 环形物



**married** ['mæɪrɪd]  
adj. 已婚的

**bun** [bʌn]  
n. 发髻

**fold** [fɒld]  
v. 交叠  
\* **fold arms**  
双手抱胸

## middle-aged

**moustache** [məʊ'stæʃ]  
n. 八字胡



**middle-aged** ['mɪdl.edʒd]  
adj. 中年的

**male** [meɪl]  
adj. 男的

**guy** [gaɪ]  
n. [口] 男人

## sore

**sore** [sor]  
*adj.* 疼痛发炎的

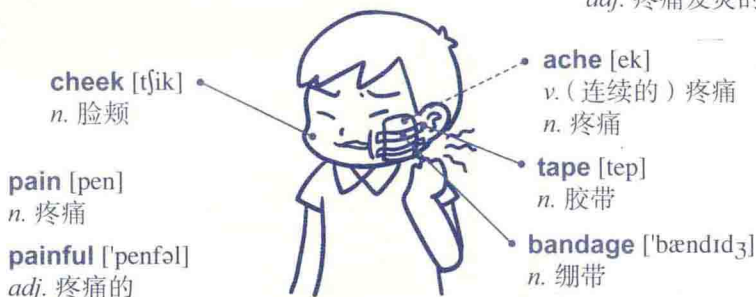

## sick

**sick** [sɪk]  
*adj.* 生病的

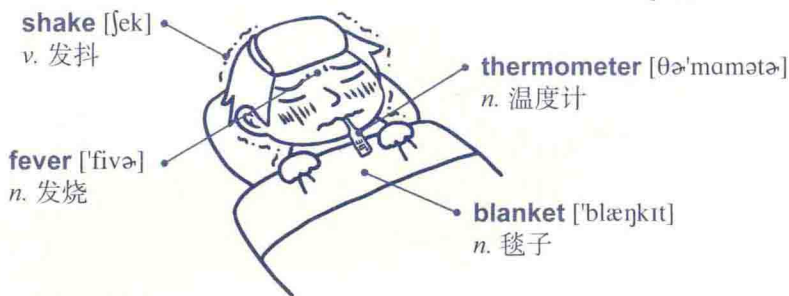

## pale

**pale** [peɪl]  
*adj.* 苍白的



## tired

sleepy ['slɪpɪ]

adj. 疲乏的

exhausted [ɪɡ'zɔ:stɪd]

adj. 筋疲力竭的

sigh [saɪ]

v. 叹气



tired [taɪrd]

adj. 疲倦的

shoulder [ˈʃəʊldə]

n. 肩膀

sore [sɔː]

adj. 痛的

pat [pæt]

n. 拍打

## unhappy

escape [ə'skeɪp]

v. 逃脱

fly [flaɪ]

v. 飞; 飞行



unhappy [ʌn'hæpi]

adj. 不快乐的

glass [glæs]

n. 玻璃

cage [keɪdʒ]

n. 鸟笼

\* fly 的三种时态为 fly / flew / flown

## careless

slip [slɪp]

v. 滑落; 松脱

break [breɪk]

v. 打破

broken ['brəʊkən]

adj. 破碎的



careless ['kɛrlɪs]

adj. 粗心的

liquid ['lɪkwɪd]

n. 液体; 酒

\* break 的三种时态为 break / broke / broken

## sad

**sad** [sæd]

*adj.* 令人悲痛的, 悲哀的

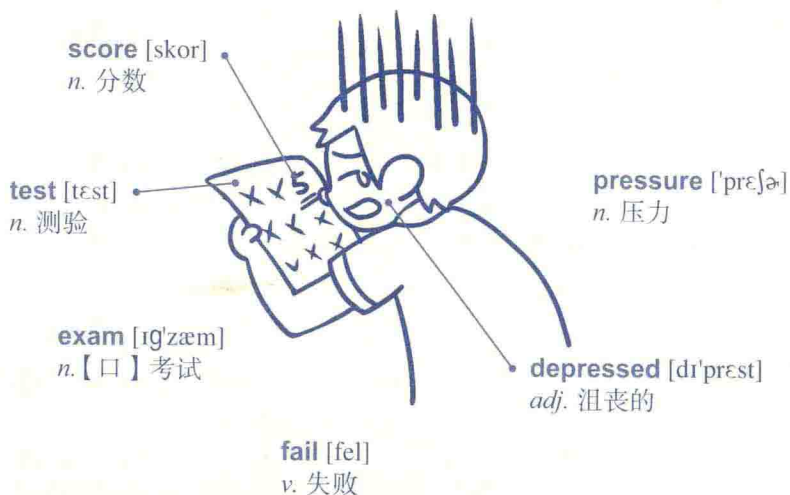

## scared

**scared** [skærd]

*adj.* 恐惧的





## scary

tongue [tʌŋ]

n. 舌头

dead [dɛd]

adj. 已死的



scary ['skɛrɪ]

adj. 吓人的

ghost [gɒst]

n. 鬼; 幽灵

## fierce

tail [teɪl]

n. 尾巴

bone [bəʊn]

n. 骨头

collar ['kɒlə]

n. 项圈



fierce [fɪrs]

adj. 凶猛的

bark [bɑ:k]

v. (狗等) 吠叫

fang [fæŋ]

n. 犬齿

## humorous

wink [wɪŋk]

v. 眨眼睛

tongue [tʌŋ]

n. 舌头

bow tie [bəʊ taɪ]

n. 领结

spot [spɒt]

n. 斑点

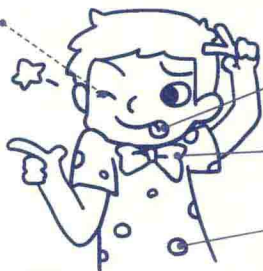

humorous ['hju:mərəs]

adj. 幽默的; 滑稽的



## nervous

**interview** ['ɪntə.vju]  
*n.* 面试; 会见



**nervous** ['nɜ:vəs]  
*adj.* 紧张的

**sweat** [swet]  
*v.* 冒汗

**anxious** ['æŋkʃəs]  
*adj.* 焦虑的

**discuss** [dɪ'skʌs]  
*v.* 讨论

## busy

**worried** ['wɜ:riəd]  
*adj.* 忧虑的

**work** [wɜ:k]  
*v.* 工作



**busy** ['bɪzi]  
*adj.* 忙碌的

**telephone** ['telə, fən]  
*n.* 电话

**paper** ['peɪpə]  
*n.* 纸

## bored



## confused

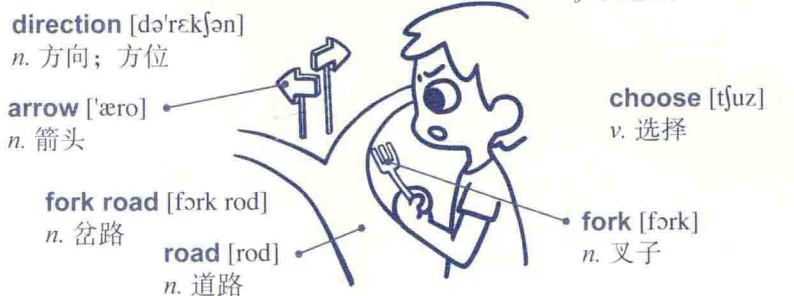

## shy



## traditional

**traditional** [trə'dɪʃənəl]

*adj.* 传统的

**costume** ['kɒstjʊm]

*n.* 服装; 戏服



**ponytail** ['pɒni,tel]

*n.* 马尾

**sash** [sæʃ]

*n.* 饰带; 腰带

## formal

**formal** ['fɔ:məl]

*adj.* 正式的

**sweat** [swet]

*n.* 汗水

*v.* 冒汗



**pain** [peɪn]

*n.* 疼痛

**headache** ['hed,ek]

*n.* 头痛

**suit** [su:t]

*n.* 套装; 西装

**button** ['bʌtən]

*n.* 钮扣

## plenty

**greedy** ['ɡri:di]  
adj. 贪心的

**hoard** [hɔ:d]  
v. 积聚钱财; 贮藏



**plenty** ['plenti]  
adj. 大量的; 充足的

**cash** [kæʃ]  
n. 现金

**bill** [bɪl]  
n. 【口】纸币

## selfish

**happy** ['hæpi]  
adj. 开心的

**candy** ['kændi]  
n. 糖果



**selfish** ['selfɪʃ]  
adj. 自私的

**jar** [dʒɑ:]  
n. 广口瓶

**empty** ['empti]  
adj. 空的



## strong

**muscle** ['mʌsəl]  
n. 肌肉

**biceps** ['baɪseps]  
n. 肱二头肌



**strong** [strɒŋ]  
adj. 强壮的

**proud** [praʊd]  
adj. 骄傲的, 得意的

## sharp

**cutlery** ['kʌtləri]  
n. 刀; 餐具

**handle** ['hændl]  
n. 柄, 把手

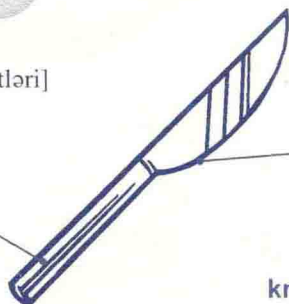

**blade** [bled]  
n. 刀身; 刀片

**knife** [naɪf]  
n. 刀

**sharp** [ʃɑ:p]  
adj. 锋利的

## pointy

**stick** [stɪk]  
v. 刺; 钉

**point** [pɔɪnt]  
n. 尖端

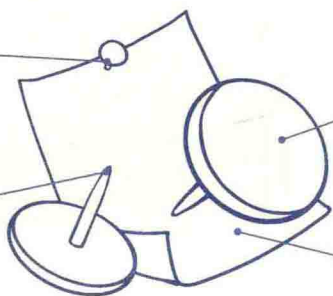

**pointy** ['pɔɪnti]  
adj. 尖的

**tack** [tæk]  
n. 大头钉; 图钉

**paper** ['peɪpə]  
n. 纸

## dangerous

**jagged** ['dʒæɡɪd]  
adj. 锯齿状的;  
有缺口的

**broken** ['brʊkən]  
adj. 破碎的



**dangerous** ['dendʒərəs]  
adj. 危险的

**sharp** [ʃɑ:p]  
adj. 锋利的

**piece** [pi:s]  
n. 一片; 一块

## sticky

**cap** [kæp]  
n. 盖子

**glue** [glu]  
n. 胶水

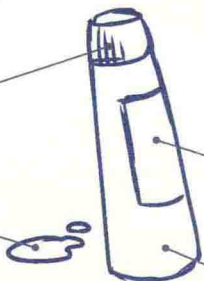

**label** ['leɪb]  
n. 标签

**bottle** ['bɒtl]  
n. 瓶子

**sticky** ['stɪki]  
adj. 黏的

**stick** [stɪk]  
v. 黏贴

## wet

**hanger** ['hæŋə]  
n. 衣架; 挂钩

**soaked** [sɔkt]  
adj. 湿透的

**T-shirt** ['ti:ʃɪt]  
n. 短袖衫; T 恤



**short sleeves**  
[ʃɔ:t slivz]  
n. 短袖

**droplet** ['drɒplɪt]  
n. 小水滴

**wet** [wɛt]  
adj. 潮湿的

## long

**eraser** ['ɪresə]  
n. 橡皮擦

**pencil** ['pensl]  
n. 铅笔

**sharp** [ʃɑ:p]  
adj. 尖的

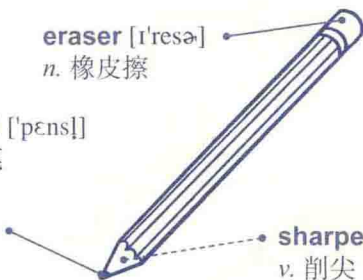

**sharpen** [ʃɑ:pən]  
v. 削尖

**write** [raɪt]  
v. 书写

**long** [lɒŋ]  
adj. 长的

## straight

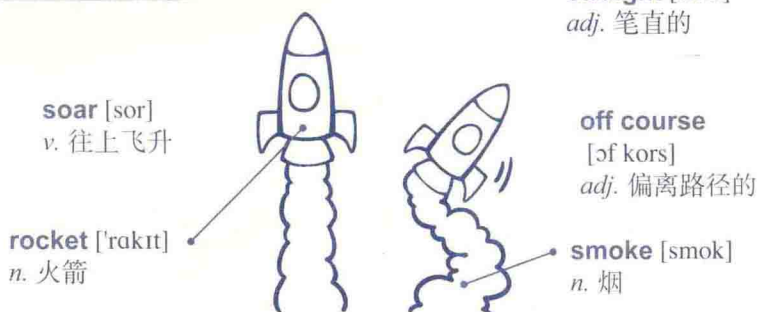

## recyclable

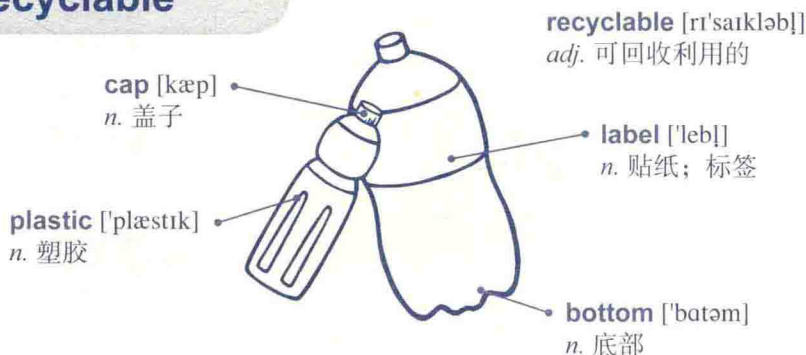

## expensive





## bright

hang [hæŋ]

v. 悬挂; 吊着

lantern ['læntən]

n. 灯笼

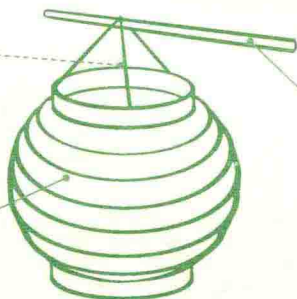

bright [braɪt]

adj. 明亮的

stick [stɪk]

n. 小棍子; 枝条

light [laɪt]

n. 光线

## clear

channel ['tʃænl]

n. 频道

station ['steɪʃən]

n. 电视台; 电台

TV set ['ti:vi seɪt]

n. 电视机

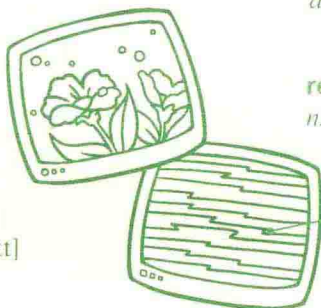

clear [klaɪr]

adj. 清晰的; 清澈的

reception [rɪ'seɪpʃən]

n. 接收效果

static ['stætɪk]

n. 静电干扰

## transparent

edge [ɛdʒ]

n. 边缘

bottom ['bɒtəm]

n. 底部



transparent [træns'pærənt]

adj. 透明的

glass [glæs]

n. 玻璃

glassware ['glæs.wɛr]

n. 玻璃器皿

paw print [pɔ:prɪnt]

n. 爪子形状的花纹

## smoky

**smoky** ['smɒki]

*adj.* 冒烟的 -

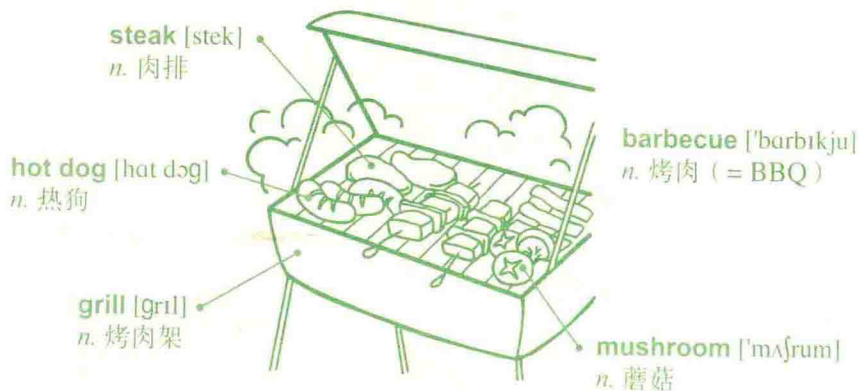

## smelly

**smelly** ['smɛli]

*adj.* 臭的

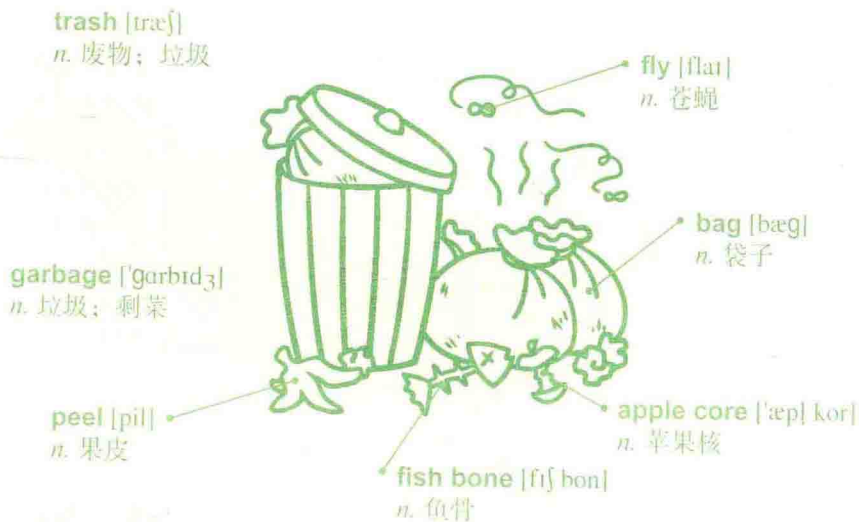

## juicy

peach [pitʃ]

n. 桃子

fruit [fru:t]

n. 水果

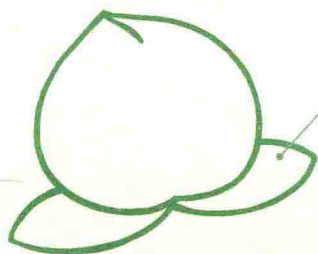

leaf [lif]

n. 叶子

ripe [raip]

adj. (果实) 成熟的

juicy [ˈdʒʊsi]

adj. 多汁的

## sour

squeeze [skwiz]

v. 挤

tongue [tʌŋ]

n. 舌头

lemon [ˈlemən]

n. 柠檬



sour [ˈsaʊə]

adj. 酸的

squint [skwɪnt]

v. 眯着眼看

peel [pi:l]

n. 果皮

v. 削皮

## tender

plate [plet]

n. 碟子

garnish [ˈɡɑ:nɪʃ]

n. 盘饰

dish [dɪʃ]

n. 菜肴

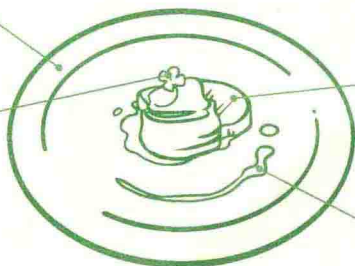

tender [ˈtɛndə]

adj. 软嫩的

steak [stek]

n. 牛排

sauce [sɔ:s]

n. 酱汁

## hidden

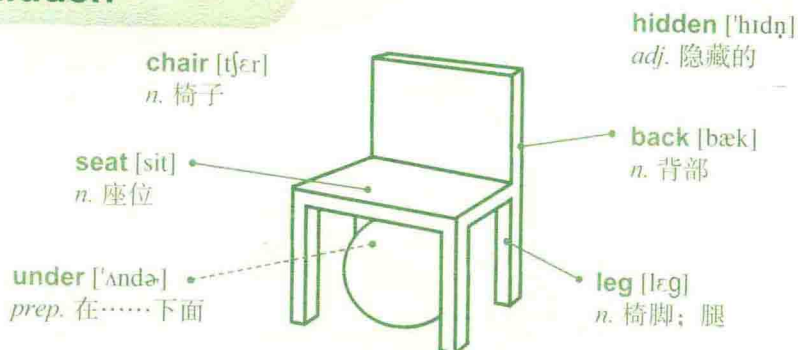

## open

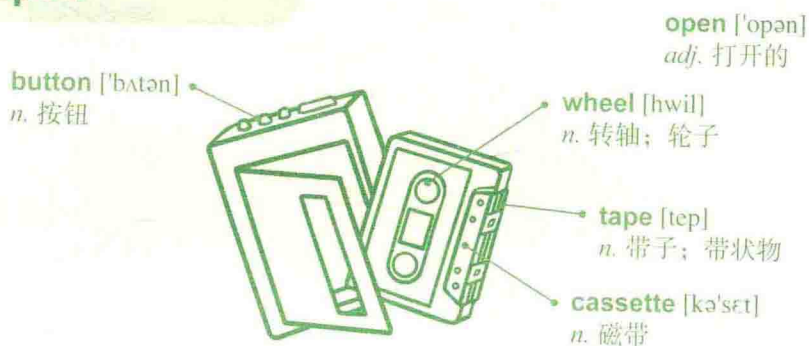

## broken



## thin

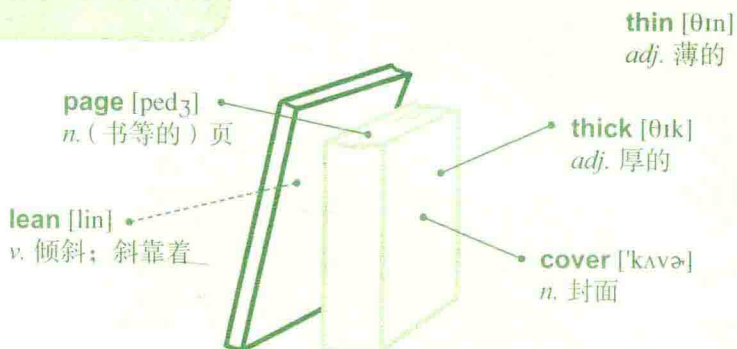

## thick

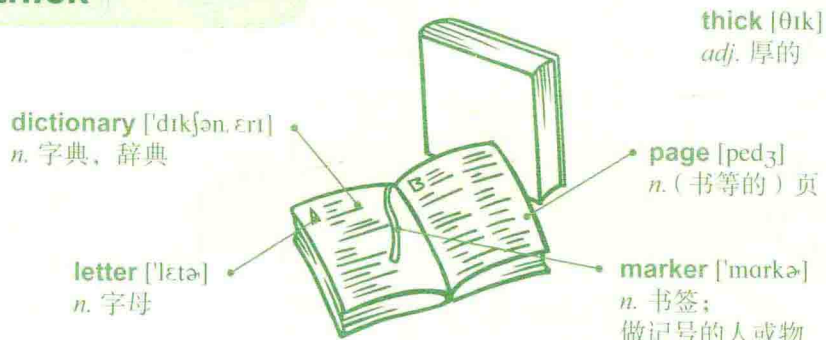

## portable

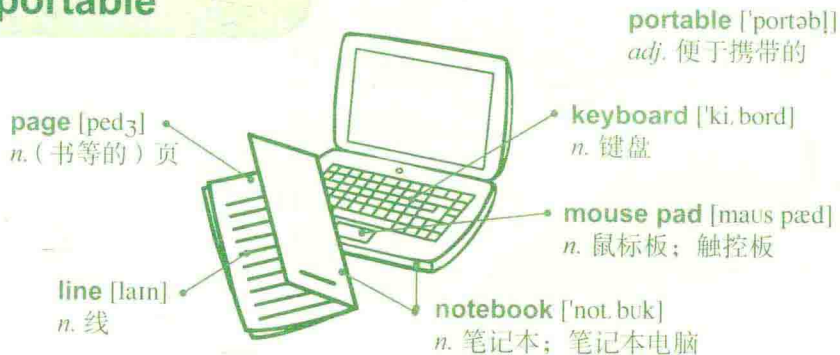

# Day 9 动词

- shake
- strike
- grab
- curtsy
- bow
- fight
- battle
- steal
- rob
- smoke
- sit
- slide
- roll
- hold
- water
- share
- dance
- kiss
- create
- draw
- giggle
- cry
- chat
- pray
- shiver
- sneeze
- lift
- sleep
- climb
- pick up
- step over
- raise
- cut
- exchange
- paint
- sweep
- wash
- give
- ask
- lead
- applaud
- win
- dig
- walk
- circle
- put
- lie
- push

## shake

**shake** [ʃeɪk]  
v. 摇动; 抖动

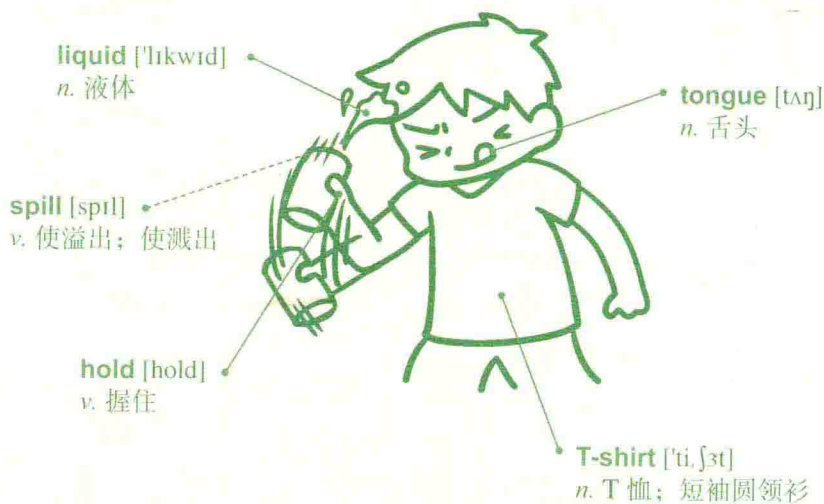

## strike

**strike** [straɪk]  
v. 打, 敲打





## grab

grab [græb]

v. 抓取

table ['teɪb]  
n. 桌子seal [si:l]  
n. 封蜡envelope ['envə, lɒp]  
n. 信封take [teɪk]  
v. 拿取

## curtsey

curtsey ['kɜ:tsi]

v. 行屈膝礼

\* 女子将一脚放在另一脚后，微弯膝盖向他人致敬

hair band [hɛr bænd]  
n. 发带；发箍eyelash ['aɪ. læʃ]  
n. (一根) 眼睫毛friendly ['frɛndli]  
adj. 友好的crease [kri:s]  
n. 折痕；皱纹

## bow

bow [bau]

v. 鞠躬

take off [teɪk ɒf]  
ph. 脱下gentleman ['dʒɛntlmən]  
n. 绅士suit [su:t]  
n. 西装manners ['mænəz]  
n. 礼貌

## fight

**angry** ['æŋɡri]  
*adj.* 生气的

**attack** [ə'tæk]  
*v.* 攻击

**punch** [pʌntʃ]  
*v.* 出拳打……

**fist** [fɪst]  
*n.* 拳



**fight** [faɪt]  
*v.* 打架  
*n.* 打架

**mad** [mæd]  
*adj.* 抓狂的

## battle

**fight** [faɪt]  
*v.* 搏斗; 打架

**pirate** ['paɪrət]  
*n.* 海盗

**sword** [sɔ:rd]  
*n.* 刀; 剑

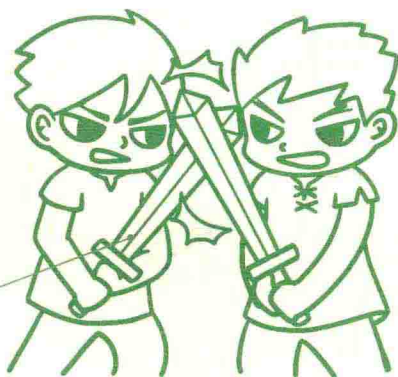

**battle** ['bætl]  
*v.* 对战  
*n.* 战斗

**struggle** ['strʌɡl]  
*v.* 对抗; 争斗  
*n.* 争斗

## steal



\* thief 的复数形式为 thieves [θivz]

## rob

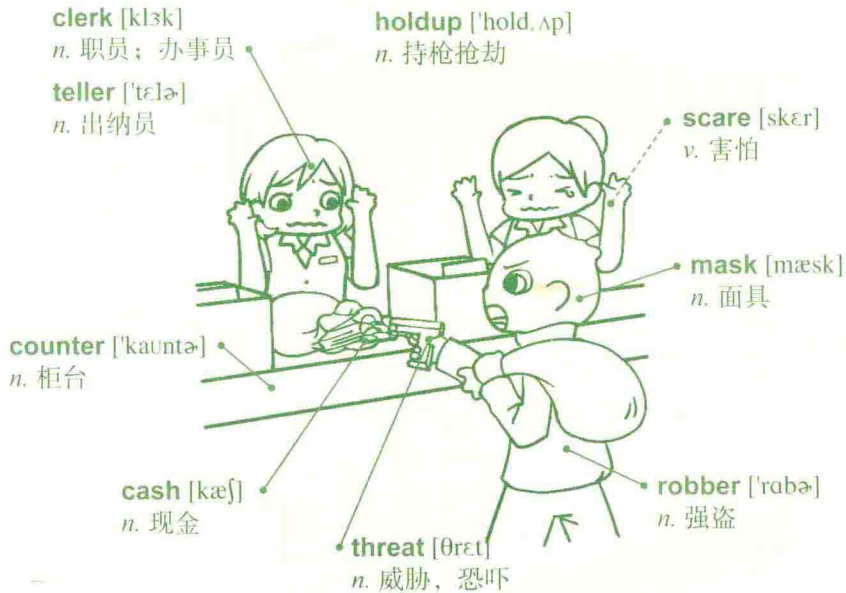

## smoke

**tobacco** [tə'bæko]  
n. 烟草

**pipe** [paɪp]  
n. 烟斗

**apron** ['eprən]  
n. 围裙



**smoke** [smok]  
v. 抽烟  
n. 烟

**cap** [kæp]  
n. 无边便帽

**moustache** [mə'stæʃ]  
n. 八字胡

## sit

**student** ['stju:dənt]  
n. 学生

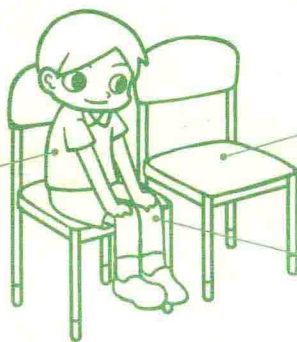

**sit** [sɪt]  
v. 坐下; 就座

**chair** [tʃeə]  
n. 椅子

**knee** [ni:  
n. 膝盖

## slide

**slide** [slaid]  
n. 滑滑梯

**playground** ['pleɪgraʊnd]  
n. (儿童) 游乐场



**slide** [slaid]  
v. 滑

**stair** [steə]  
n. 梯阶; 踏阶

**step** [step]  
n. 踏阶; 步

**curve** [kɜ:v]  
n. 曲线; 弯曲的物品

## roll

**roll** [rɒl]  
v. 卷; 滚动

**carpet** ['kɑ:pɪt]  
n. 地毯

**rug** [rʌg]  
n. 小地毯



**long** [lɔŋ]  
adj. 长的

## hold

**hold** [həʊld]  
v. 抓住; 握住

**coin** [kɔɪn]  
n. 钱币

**money** ['mʌni]  
n. 钱; 货币

**elbow** ['ɛlboʊ]  
n. 手肘



**valuable** ['væljuəbəl]  
adj. 值钱的

## water

**water** ['wɔ:tə]  
v. 浇水

**water** ['wɔ:tə]  
n. 水

**petal** ['petl]  
n. 花瓣

**grow** [grəʊ]  
v. 生长



**hose** [hoʊz]  
n. 水管, 软管

**garden** ['gɑ:dən]  
n. 花园

## share

**share** [ʃeɪ]  
v. 分享

**piece** [piːs]  
n. 一片; 一块

**cookie** ['kʊki]  
n. 小饼干; 甜面包

\* give 的三种时态为  
give / gave / given

**give** [ɡɪv]  
v. 给予



## dance

**dance** [dɑːns]  
v. 跳舞

**waltz** [wɔːltz]  
n. 华尔兹舞曲  
v. 跳华尔兹舞

**ball** [bɔːl]  
n. 舞池

**elegant** ['eləɡənt]  
adj. 优雅的

**partner** ['pɑːtnə]  
n. 舞伴; 伙伴



## kiss

**kiss** [kɪs]  
v. 亲吻

**puppy love** ['pʌpi lʌv]  
n. 幼稚之爱

**lip** [lɪp]  
n. 嘴唇

**ear** [ɪr]  
n. 耳朵

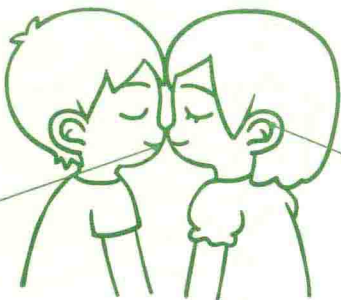

## create

**create** [kri'eɪt]  
v. 创作

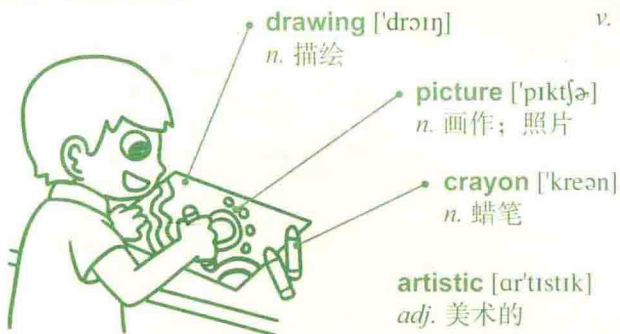

**drawing** ['drɔ:ɪŋ]  
n. 描绘

**picture** ['pɪktʃə]  
n. 画作; 照片

**crayon** ['kreɪn]  
n. 蜡笔

**artistic** [ɑ:'tɪstɪk]  
adj. 美术的

## draw

**draw** [drɔ:]  
v. 画

**crayon** ['kreɪn]  
n. 有色粉笔; 蜡笔

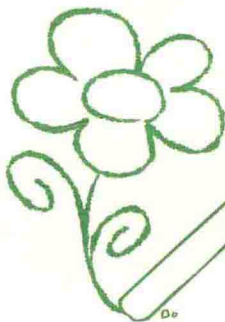

**chalk** [tʃɔ:k]  
n. 粉笔

**chalk stick** [tʃɔ:k stɪk]  
n. 粉笔

**color** ['kʌlə]  
v. 着色  
n. 颜色

**drawing** ['drɔ:ɪŋ]  
n. 描绘

**picture** ['pɪktʃə]  
n. 图画; 照片

**crayon** ['kreɪn]  
n. 蜡笔

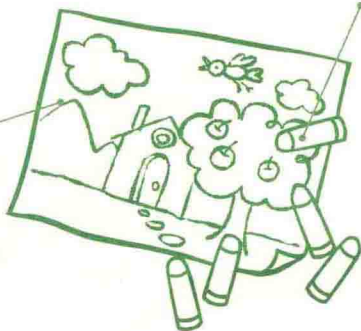



## giggle

**chuckle** ['tʃʌkl]

v. 咯咯笑; 暗自发笑

**fun** [fʌn]

n. 乐趣

adj. 有趣的

**funny** ['fʌni]

adj. 有趣的; 滑稽可笑的



**giggle** ['gɪɡl]

v. 咯咯笑

**laugh** [lɑːf]

v. 笑

**enjoyable** [ɪn'dʒɔɪəbəl]

adj. 快乐的

## cry

**loud** [laʊd]

adj. 大声的

**sad** [sæd]

adj. 伤心的

**tear** [tɪr]

n. 眼泪



**angry** ['æŋɡrɪ]

adj. 生气的



**cry** [kraɪ]

v. 哭

v. 大吼

**squint** [skwɪnt]

v. 挤眼睛

**shout** [ʃaʊt]

v. 大喊, 喊叫

**yell** [jɛl]

v. 叫喊

## chat

**conversation** [.kɒnvə'seɪʃən]

n. 谈话

**eyelash** ['aɪ.læʃ]

n. 睫毛

**palm** [pɑːm]

n. 手掌, 手心



**chat** [tʃæt]

v. 闲谈, 聊天

**finger** ['fɪŋɡə]

n. 手指

## pray

**pray** [preɪ]  
v. 祈祷

**cross** [krɒs]  
n. 十字架

**clasp** [klæsp]  
v. 紧握



**Catholic** ['kæθəlɪk]  
n. 天主教徒  
adj. 天主教的

**Christianity** [ˌkrɪstɪˈænəti]  
n. 基督教

## shiver

**shiver** [ʃɪvə]  
v. 发抖

**sofa** ['sɒfə]  
n. 沙发

**couch** [kaʊtʃ]  
n. 长沙发

**scary** ['skəri]  
adj. 惊吓的

**scare** [skeɪ]  
v. 惊吓、使恐惧



**afraid** [ə'freɪd]  
adj. 害怕的

**frightened** ['fraɪtənd]  
adj. 受惊吓的

**blanket** ['blæŋkɪt]  
n. 毯子

## sneeze

**sneeze** [snɪz]  
v. 打喷嚏  
n. 喷嚏（声）

**wind** [wɪnd]  
n. 风

**tear** [tɪr]  
n. 眼泪

**handkerchief** ['hæŋkjə,tʃɪf]  
n. 手帕

**tissue** ['tɪʃu]  
n. 面巾纸；卫生纸

**blow** [bləʊ]  
v. 擤鼻涕



## lift

**lift** [lɪft]  
v. 举起

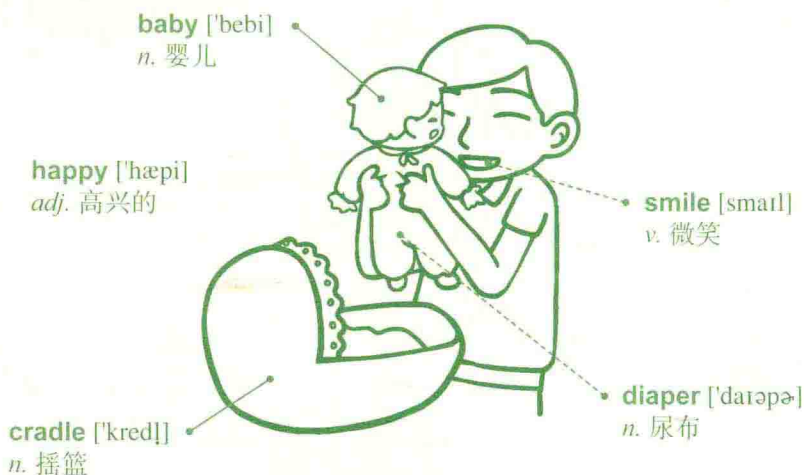

## sleep

**sleep** [slɪp]  
v. 睡觉

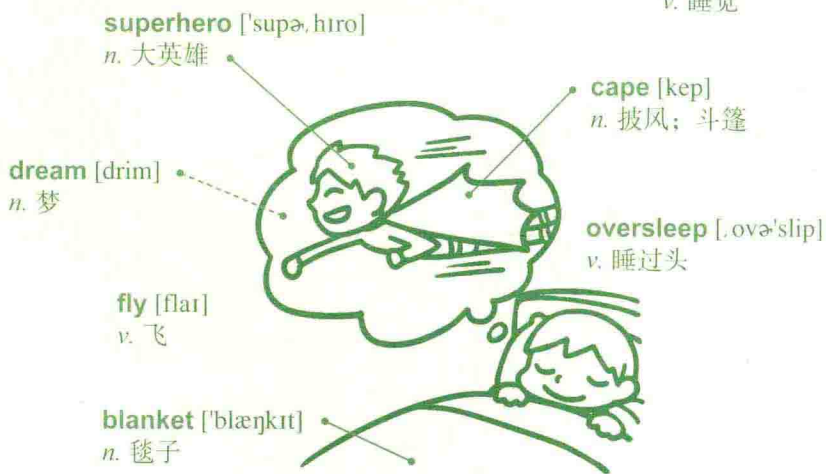

## climb

climb [klaɪm]

v. 爬上; 攀登

branch [bræntʃ]

n. 树枝

grasp [græsp]

v. 抓牢; 抱住

T-shirt ['ti:ʃɜ:t]

n. 短袖圆领衫

tree [tri:]

n. 树; 乔木



## pick up

pick up [pɪk ʌp]

ph. 接起

ring [rɪŋ]

n. 铃声

call [kɔ:l]

v. 来电

receiver [rɪ'si:və]

n. 话筒

cord [kɔ:rd]

n. 粗线



## step over

step over [step 'ovə]

ph. 跨越

sidewalk ['saɪd.wɔ:k]

n. 人行道

gutter ['gʌtə]

n. 排水沟



## raise

**flagpole** ['flæg.pəʊl]  
n. 旗杆

**line** [laɪn]  
n. 绳子; 线

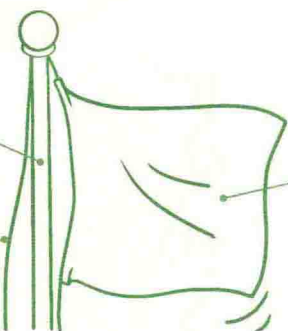

**raise** [reɪz]  
v. 升起

**flag** [flæg]  
n. 旗帜

**flap** [flæp]  
v. 飘扬

## cut

**sharp** [ʃɑ:p]  
adj. 锋利的

**scissors** ['sɪzəz]  
n. 剪刀

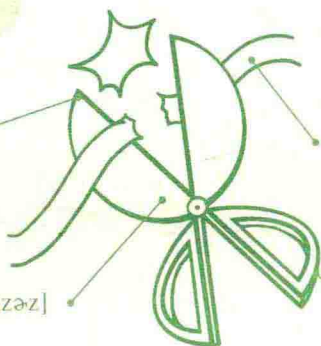

**cut** [kʌt]  
v. 剪

**ribbon** ['rɪbən]  
n. 缎带

**handle** ['hændl]  
n. 把手

## exchange

**amount** [ə'maʊnt]  
n. 总数

**bill** [bɪl]  
n. 【口】纸币

**divide** [dɪ'vaɪd]  
v. 分开

**money** ['mʌni]  
n. 钱; 货币

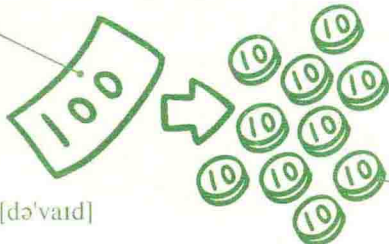

**exchange** [ɪks'tʃeɪndʒ]  
v. 交换; 兑换

**change** [tʃeɪndʒ]  
n. 零钱

**coin** [kɔɪn]  
n. 硬币

## paint

**smelly** ['smɛli]  
adj. 有臭味的

**brush** [brʌʃ]  
n. 刷

**paint brush** [peɪnt brʌʃ]  
n. 油漆刷; 画笔

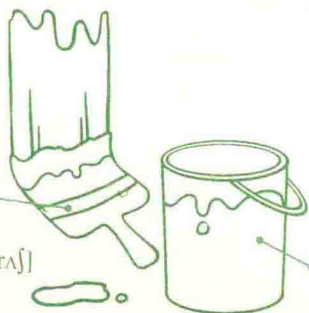

**paint** [peɪnt]  
v. 涂油漆; 作画

**messy** ['mɛsi]  
adj. 凌乱的

**paint can** [peɪnt kæn]  
n. 油漆罐

## sweep

**chore** [tʃɔːr]  
n. 家庭杂务

**housework** ['haʊs, wɜːk]  
n. 家务

**mop** [mɒp]  
n. 拖把



**handle** ['hændl]  
n. 握柄

**broom** [brʊm]  
n. 扫帚

**sweep** [swi:p]  
v. 清扫

## wash

**faucet** ['fɔːsɪt]  
n. 水龙头

**tap** [tæp]  
n. 水龙头



**wash** [wɒʃ]  
v. 洗

**turn on** [tɜːn ɒn]  
ph. 打开

**turn off** [tɜːn ɔːf]  
ph. 关紧

# give

give [gɪv]  
v. 给予

presentation [ˌprɪzən'teɪʃən]

n. 简报

\* give a presentation  
做简报

graph [græf]

n. 曲线图

chart [tʃɑ:t]

n. 图表; 曲线图

boardroom ['bɔ:d, rʊm]

n. 会议室

meeting ['mi:tɪŋ]

n. 会议

tend [tɛnd]

v. 走势

present [prɪ'zent]

v. 呈献

staff [stæf]

n. (全体) 职员

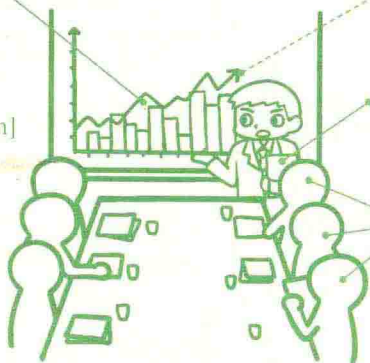

# ask

ask [æsk]  
v. 提问; 询问

math [mæθ]

n. 【口】 数学  
(= mathematics  
[ˌmæθə'mætɪks])

stick [stɪk]

n. 教鞭

question mark

['kwɛstʃən mark]  
n. 问号

glasses ['glæsɪz]

n. 眼镜

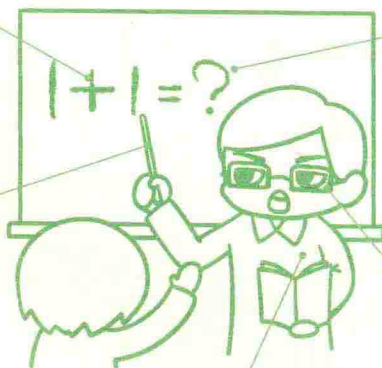

teacher ['ti:tʃə]

n. 教师



## lead

rage [redʒ]

n. 狂怒, 盛怒

mob [mɒb]

n. (一群) 暴民,  
乌合之众

lead [li:d]

v. 引导; 带头

leader ['li:də]

n. 领袖

revolt [rɪ'vɒlt]

v. 起义; 造反

revolution [,rɛvə'lju:ʃən]

n. 革命

## applaud

audience ['ɔ:diəns]

n. 观众



applaud [ə'plɒd]

v. 鼓掌

approve [ə'pru:v]

v. 赞成

encourage [ɪn'kʌrɪdʒ]

v. 鼓励

## win

certificate [sə'tɪfɪkət]

n. 证书

prize [praɪz]

n. 奖赏



win [wɪn]

v. 获胜

award [ə'wɔ:rd]

v. 颁奖

n. 奖; 奖品

winner ['wɪnə]

n. 优胜者

## dig



\* dig 的三种时态为 dig/dug/dug

## walk



## circle



## put

**round** [raʊnd]  
adj. 球形的; 圆形的

**shelf** [ʃelf]  
n. 架子; 搁板



**put** [put]  
v. 放

**place** [ples]  
v. 置放

**bowl** [bɒl]  
n. 碗

## lie

**wolf** [wʊlf]  
n. 狼

**dog** [dɒg]  
n. 狗



**lie** [laɪ]  
v. 说谎

**angry** ['æŋɡri]  
adj. 发怒的, 生气的

**cane** [ken]  
n. 拐杖

**sandal(s)** ['sændl]  
n. 凉鞋

\* lie (意思为“说谎”时)的三种时态为 lie/lie/d

## push

**hurt** [hɜ:t]  
n. 痛

**force** [fɔ:s]  
v. 强迫

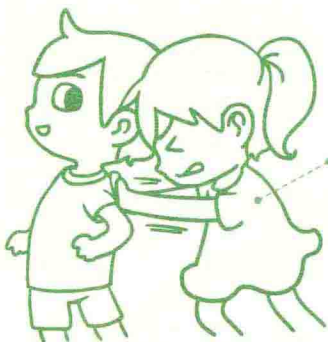

**push** [puʃ]  
v. 推

**rush** [rʌʃ]  
v. 催促

# Day 10 名词

- letter
- postcard
- comic book
- rope
- paste
- bell
- workbook
- chalkboard
- pen
- marker
- eraser
- ruler
- bench
- bookcase
- sign
- screen
- nail
- brooch
- sash
- towel
- beach ball
- gift
- fist
- robot
- treadmill
- coin
- bill
- prize
- restroom
- bridge
- creek
- island
- world map
- millionaire
- office
- performance
- band
- audience
- poker
- neighbor
- seesaw
- movie
- speech
- crowd
- fur
- fireman
- candy
- butter
- color

## letter

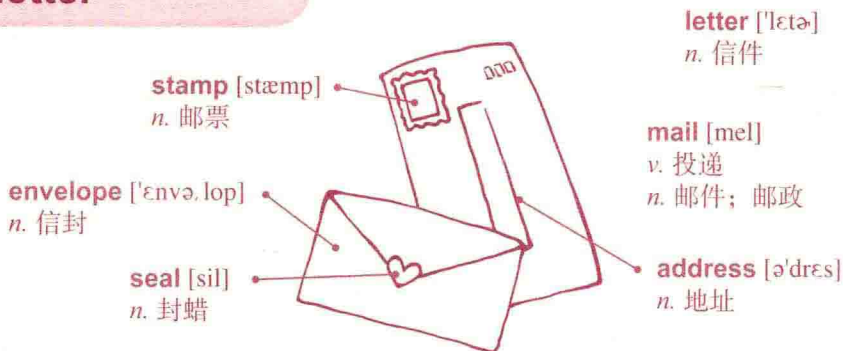

## postcard

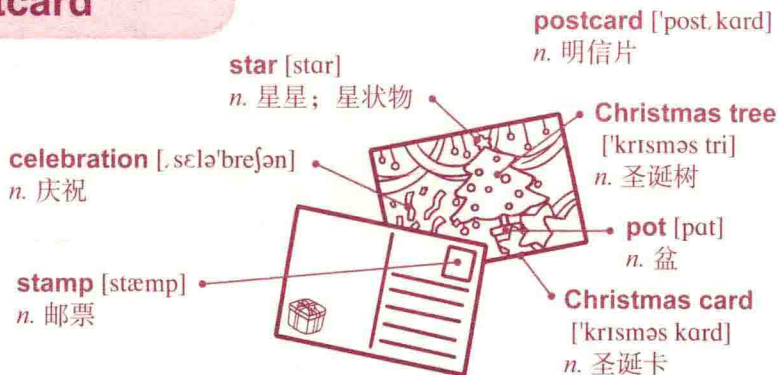

## comic book



## rope

**circular** ['sɜ:kjələ]  
adj. 环状的; 圆形的

**coil** [kɔɪl]  
v. 盘绕



**rope** [rɒp]  
n. 绳索

**end** [ɛnd]  
n. 末端

## paste

**jar** [dʒɑːr]  
n. 宽口瓶



**glue** [gluː]  
n. 黏着剂; 胶水

**sticky** ['stɪki]  
adj. 黏稠的

**drip** [drɪp]  
v. 滴落

**lid** [lɪd]  
n. 盖子

**paste** [peɪst]  
n. 浆糊

## bell

**handle** ['hændl]  
n. 柄状物

**ring** [rɪŋ]  
v. 摇铃; 按铃



**bell** [bɛl]  
n. 铃; 门铃

**point** [pɔɪnt]  
v. 指

## workbook

**capital letter** ['kæpət]'letə]

*n.* 大写字母

**small letter** [sməl]'letə]

*n.* 小写字母

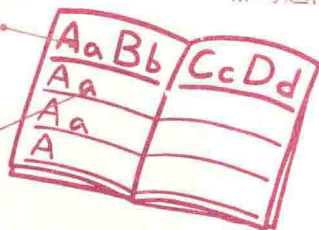

**workbook** ['wɜ:k.bʊk]

*n.* 习题簿; 练习簿

**practice book** ['præktɪs.bʊk]

*n.* 练习本

**homework** ['hɒm.wɜ:k]

*n.* 家庭作业

## chalkboard

**chalkboard** ['tʃɔ:k.bɔ:rd]

*n.* 黑板

**formula** ['fɔ:mjələ]

*n.* 公式

**blackboard** ['blæk.bɔ:rd]

*n.* 黑板

**angle** ['æŋɡl]

*n.* 角; 角度

**triangle** ['traɪ.æŋɡl]

*n.* 三角形

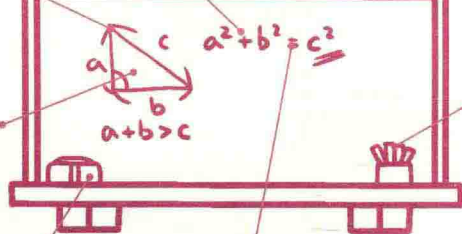

**eraser** ['ɪresə]

*n.* 板擦

**chalk** [tʃɔ:k]

*n.* 粉笔

**equal** ['i:kwəl]

*v.* 加总

*adj.* 等于; 相等的



## pen



## marker

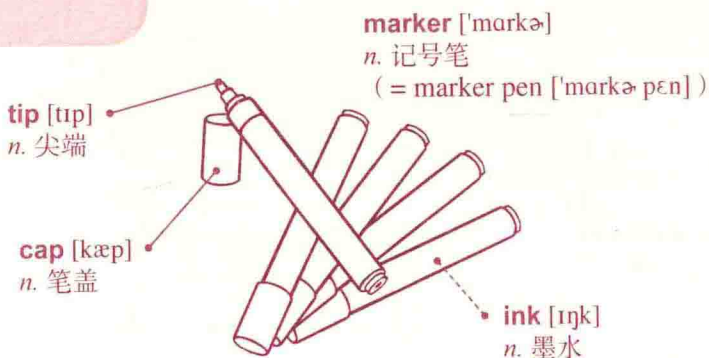

## eraser

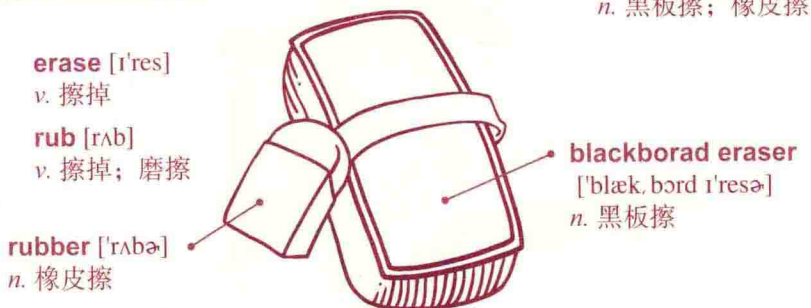

## ruler

**centimeter** ['sentə, mitə]

*n.* 厘米 = cm

**meter** ['mitə]

*n.* 米 = m

**inch** [ɪntʃ]

*n.* 英寸 = in.

**foot** [fʊt]

*n.* 英尺 = ft.

**ruler** ['ru:lə]

*n.* 尺

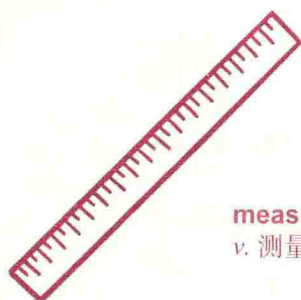

**measure** ['meɪʒə]

*v.* 测量

\* inch 的复数形式为 inches [ɪntʃs]

\* foot 的复数形式为 feet [fi:t]

## bench

**nail** [neɪ]

*n.* 钉子

**wooden** ['wʊdn]

*adj.* 木制的

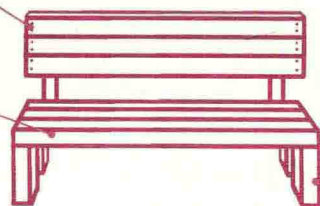

**bench** [bentʃ]

*n.* 长椅

**outdoor** ['aʊt.dɔː]

*adj.* 户外的

**leg** [leɪ]

*n.* 椅脚

## bookcase

**high** [haɪ]

*adj.* 高的

**low** [ləʊ]

*adj.* 低的; 浅的

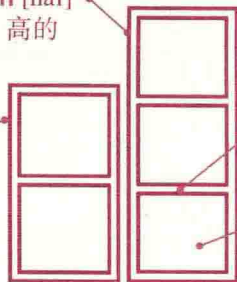

**bookcase** ['buk. kes]

*n.* 书架

**shelf** [ʃelf]

*n.* (书橱等的) 架子

**empty** ['emptɪ]

*adj.* 空的

## sign

sign [saɪn]

n. 标志

traffic ['træfɪk]

n. 交通

triangle ['traɪ.æŋɡl]

n. 三角形

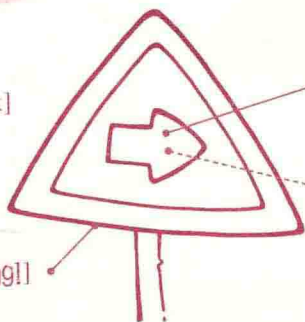

arrow ['æro]

n. 箭头

one-way ['wʌn.weɪ]

adj. 单行道 (的指示)

## screen

screen [skri:n]

n. 屏幕

monitor ['mɒnətə]

n. 显示器, 监视器

LED

n. 液晶屏幕

[= Light Emitting Diode (display)

[laɪt ɪ'mɪt 'daɪəd (dɪ'spleɪ)]

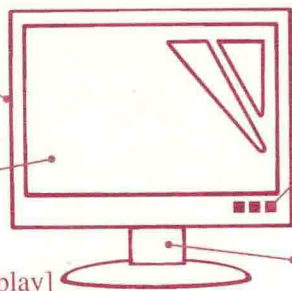

button ['bʌtən]

n. 按钮

stand [stænd]

n. 架子; 座

## nail

nail [neɪl]

n. 钉子

metal ['metl]

n. 金属; 合金

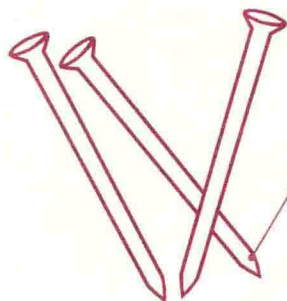

point [pɔɪnt]

n. 尖端

## brooch

**ornament** ['ɔ:nəmənt]

*n.* 装饰品

**decoration** [ˌdekə'reʃən]

*n.* 装饰

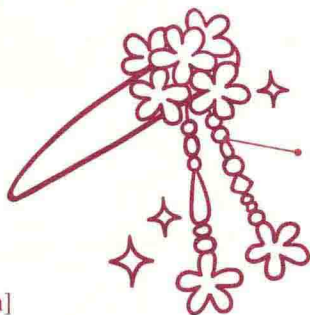

**brooch** [brɒtʃ]

*n.* 女用胸针

**bead** [bi:d]

*n.* 串珠; 小珠子

## sash

**hold** [həʊld]

*v.* 握着; 抓住

**skirt** [skɜ:t]

*n.* 裙子



**sash** [sæʃ]

*n.* 肩带; 腰带

**ponytail** ['pɒniːteɪl]

*n.* 马尾

**long** [lɒŋ]

*adj.* 长的

## towel

**twist** [twɪst]

*v.* 扭转; 拧、绞

**wet** [wɛt]

*adj.* 潮湿的



**towel** ['tauəl]

*n.* 毛巾; 纸巾

**dry** [draɪ]

*v.* 弄干

## beach ball

beach ball [bi:tʃ bɔ:l]

n. 沙滩球

stripe [straɪp]

n. 条纹

box [bɒks]

n. 箱子

container [kən'teɪnə]

n. 容器 (如箱子、罐子)

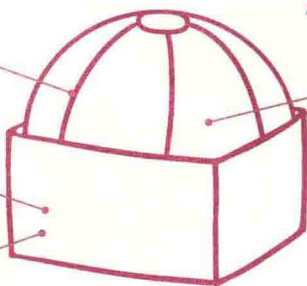

ball [bɔ:l]

n. 球

inside [ɪn'saɪd]

n. 内部, 里面

## gift

gift [ɡɪft]

n. 礼物

sad [sæd]

adj. 悲哀的

disappointed [ˌdɪsə'pɔɪntɪd]

adj. 失望的



down [daʊn]

adj. 心情低落的

depressed [dɪ'prest]

adj. 沮丧的

## fist

fist [fɪst]

n. 拳头

shout [ʃaʊt]

v. 大叫

hand [hænd]

n. 手

pound [paʊnd]

v. 捶

arm [ɑ:m]

n. 手臂



## robot

**robot** ['rɒbət]

*n.* 机器人; 遥控装置

**antenna** [æn'tenə]

*n.* 天线

**electricity** [ˌɪlek'trɪsəti]

*n.* 电; 电流

**metal** ['metl]

*n.* 金属; 合金

**science fiction** ['saɪəns 'fɪkʃən]

*n.* 科幻小说

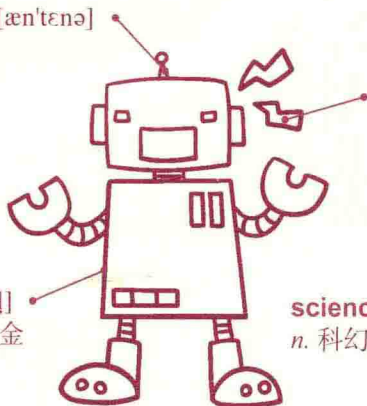

## treadmill

**treadmill** ['tred.mɪl]

*n.* 跑步机

**gymnasium** [dʒɪm'neɪzɪəm]

*n.* 健身房 (= gym [dʒɪm])

**run** [rʌn]

*v.* 跑步

**tired** [taɪrd]

*adj.* 疲劳的

**exercise** ['eksə.sɪz]

*n.* 运动



## coin

**tails** [teɪls]  
n. (硬币的)  
反面、背面

**heads** [hɛdɪz]  
n. (硬币的) 正面

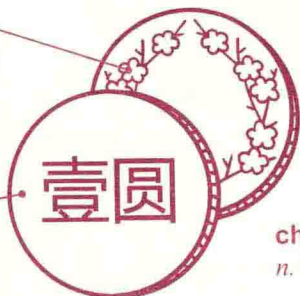

**coin** [kɔɪn]  
n. 硬币

**money** ['mʌni]  
n. 钱; 货币

**change** [tʃeɪndʒ]  
n. 零钱

## bill

**dollar** ['dɒlə]  
n. (美、加等国) 元

**banknote** ['bæŋknoʊt]  
n. 法定货币

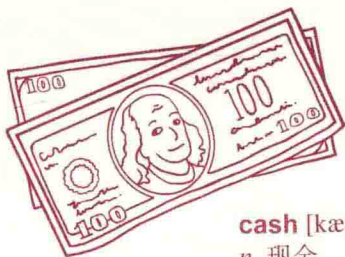

**bill** [bɪl]  
n. [口] 纸币

**money** ['mʌni]  
n. 钱; 货币

**cash** [kæʃ]  
n. 现金

## prize

**trophy** ['trɒfi]  
n. 奖杯; 优胜纪念品

**check** [tʃɛk]  
n. 支票

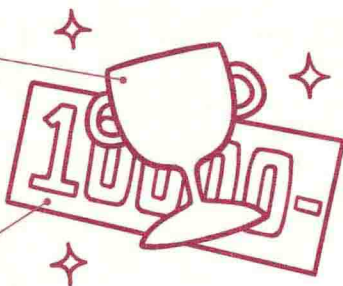

**prize** [praɪz]  
n. 奖品; 奖金

**win** [wɪn]  
v. 获胜



## restroom

**paper towel** ['pepə 'tauəl]  
n. 擦手纸

**lavatory** ['lævə, tɔ:ɪ]  
n. 厕所

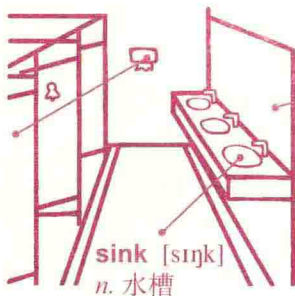

**restroom** ['rest.rum]  
n. 洗手间; 休息室  
(= rest room)

**mirror** ['mɪrə]  
n. 镜子

**tap** [tæp]  
n. 水龙头

**sink** [sɪŋk]  
n. 水槽

## bridge

**flow** [flo]  
v. (河水等) 流动

**ornament** ['ɔ:nəmənt]  
n. 装饰品

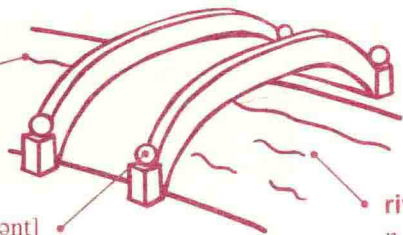

**bridge** [brɪdʒ]  
n. 桥, 桥梁

**river** ['rɪvə]  
n. 江, 河

## creek

**sit** [sɪt]  
v. 坐着

**knee** [ni]  
n. 膝盖



**creek** [kri:k]  
n. 小河, 溪流

**rock** [rɒk]  
n. 石块

## island

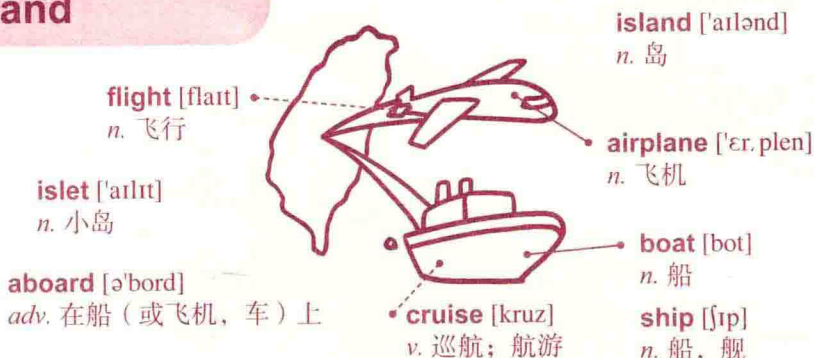

## world map

**world map** [wɜ:ld məp]  
n. 世界地图

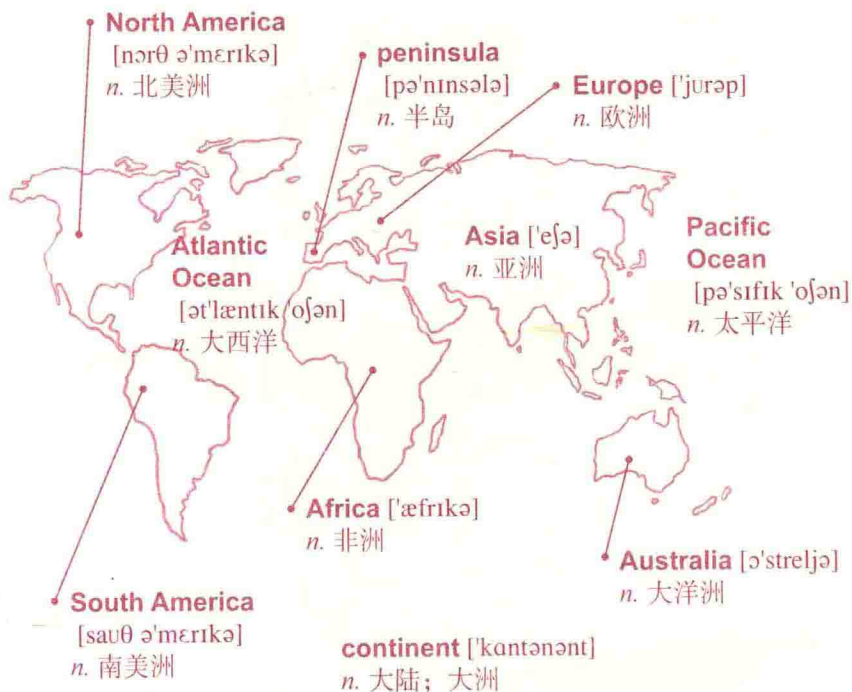

## millionaire

**wealthy** ['weɪlθɪ]  
*adj.* 富裕的

**rich** [rɪtʃ]  
*adj.* 有钱的



**millionaire** [ˌmɪljən'eɪr]  
*n.* 百万富翁

**ring** [rɪŋ]  
*n.* 戒指

**suit** [su:t]  
*n.* 西装; 套装

## office

**office** ['ɒfɪs]  
*n.* 办公室

**board** [bɔ:d]  
*n.* 木板; 壁板

**Post-it** ['pɒstɪt]  
*n.* 便利贴

**employee** [ˌemplɔɪ'i]  
*n.* 雇员

**colleague** ['kɒliɡ]  
*n.* 同事



**monitor** ['mɒnɪtə]  
*n.* 显示器

**keyboard** ['kiːbɔ:d]  
*n.* 键盘

**cubicle** ['kjuːbɪkl]  
*n.* 办公室的小隔间

## performance



## band



## audience



## poker

**lose** [luz]  
v. 输; 丧失

**cheat** [tʃit]  
v. 作弊

**cheater** [tʃitə]  
n. 作弊者

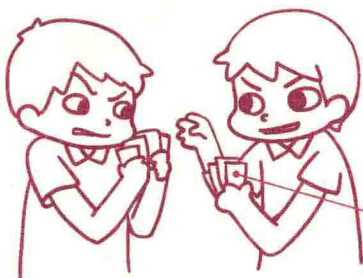

**poker** ['pokə]  
n. 扑克牌游戏

**win** [win]  
v. 赢; 获胜

**card** [kɑ:d]  
n. 纸牌

## neighbor

**married** ['mærid]  
adj. 已婚的



**neighbor** ['neibə]  
n. 邻居; 邻近的人(或物)

**neighborhood** ['neibə.hud]  
n. 邻里情谊

**couple** ['kʌpl]  
n. 情侣; (一)对

## seesaw

**up** [ʌp]  
adv. 向上  
prep. 在……上方

**board** [bɔ:d]  
n. 木板

**pivot** ['pivət]  
n. 支点; 轴



**seesaw** ['si:sə]  
n. 跷跷板

**bar** [bɑ:]  
n. 棒状物

**down** [daʊn]  
adv. 向下  
prep. 在……下方

## movie

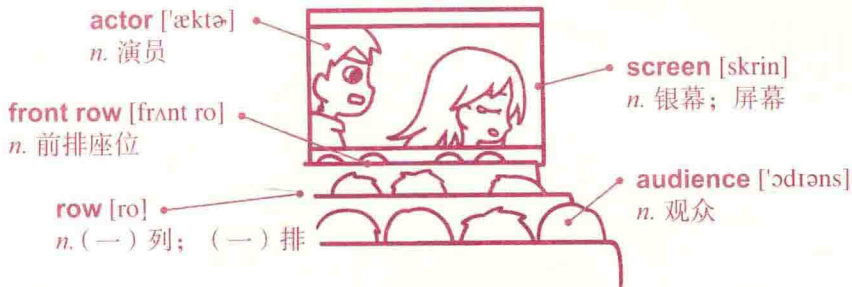

**movie** ['muvi]  
n. 电影

## speech

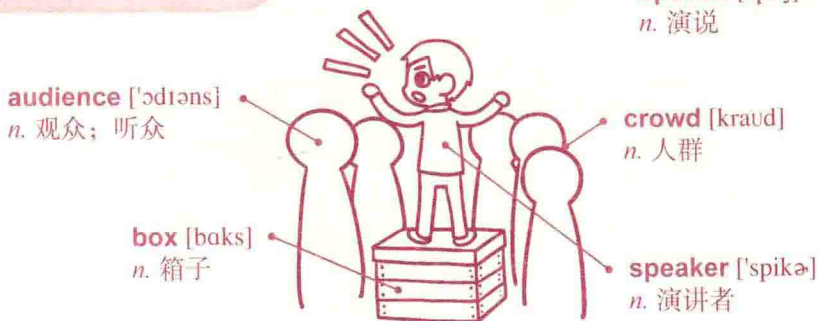

**speech** [spi:tʃ]  
n. 演说

## crowd

**lost** [lɒst]  
adj. 迷路的; 遗失的

**worried** ['wɒri:d]  
adj. 担心的



**crowd** [kraʊd]  
n. 人群

**alert** [ə'leɪt]  
adj. 警觉的

**shout** [ʃaʊt]  
v. 呼喊



## fur

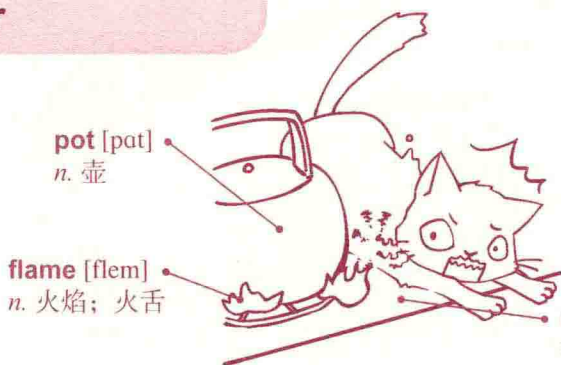

fur [fɜː]  
n. (兽类的) 皮毛

pain [peɪn]  
n. 疼痛

## fireman

misunderstand [mɪs, ʌndə'stænd]  
v. 误会

flame [fleɪm]  
n. 火焰; 火舌

smoke [sməʊk]  
n. 烟

barbecue ['bɑːbɪkjʊ]  
n. 烤肉 (= BBQ)

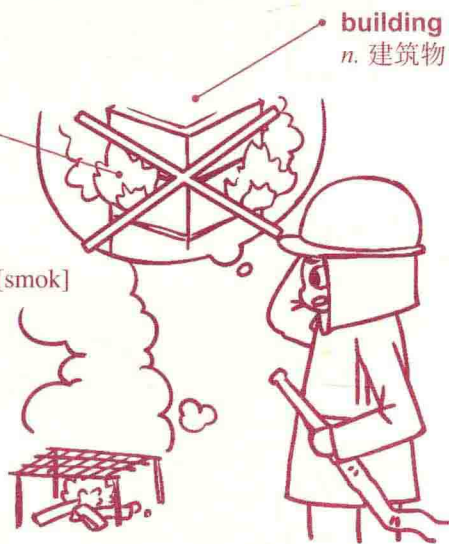

fireman ['faɪrmən]  
n. 消防队员



## candy

**sweet** [swit]  
adj. 甜的  
n. 糖果



**candy** ['kændi]  
n. 糖果

**wrapper** ['ræpə]  
n. 糖纸

**choose** [tʃuz]  
v. 选择

## butter

**box** [baks]  
n. 盒子

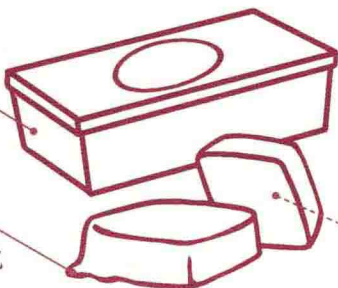

**melt** [melt]  
v. 融化; 熔化

**butter** ['bʌtə]  
n. 奶油

**yellow** ['jələʊ]  
adj. 黄色的

**frozen** ['frozən]  
adj. 冰冻的

## color

**brown** [braʊn]  
adj. 棕色的

**gray** [greɪ]  
adj. 灰色的

**pink** [pɪŋk]  
adj. 粉红色的

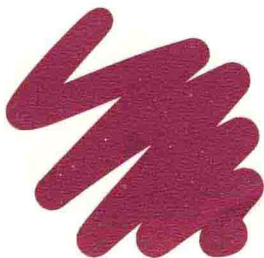

**color** ['kʌlə]  
n. 色彩

**hue** [hju:  
n. 色泽

**golden** ['gɒldən]  
adj. 金黄色的

**purple** ['pɜ:pəl]  
adj. 紫红色的